



UNSERE BESTEN JEWEILS ALS PAKET ZUM SONDERPREIS!

NOS MEILLEURS MODÈLES DANS CHAQUE CATÉGORIE EN OFFRE SPÉCIALE !

ONZE BESTE IN EEN PAKKET VOOR EEN SPECIALE PRIJS !

515.1255

MONSTER Reifen-/Räder Aktionspaket 515.1210
Pneumatiques / roues MONSTER offre promotionnelle 515.1210
MONSTER banden-/wielen actiepakket 515.1210



1690 N.m
CLASSE ROYALE / KONINKLIJKE

Max 610 Nm
Max 680 Nm
Max 931 Nm

MONSTER

R L

1/2"

515.1210 PAKETPREIS
515.1210 PRIX FORFAIT
515.1210 PAKKETPRIJS



1/2" PT
7.930 mm
178 mm
6.3 bar
89 dB-A

1,2" 10.8 mm
1,99 kg
<13,56 mm/s
104 dB

1/2"

20-200 N.m



Limited EDITION

1/2" CrMo

500W POWER

17 mm

19 mm

150 mm

INOX



515.1260

miniMONSTER Reifen-/Räder Aktionspaket 515.1270
Pneumatiques / roues miniMONSTER offre promotionnelle 515.1270
miniMONSTER banden-/wielen actiepakket 515.1270



1390 N.m
CLASSE ROYALE / KONINKLIJKE

Max 270 Nm
Max 640 Nm
Max 965 Nm

MONSTER mini

R L

1/2"

Einhandbedienung!
Utilisation d'une seule main
Eénhandbediening



1/4" PT
10.000 mm
135 mm
6.3 bar
102 dB-A

115 dB-A
<9,18 mm/s
1,34 kg
3,8" 10.8 mm

515.1270 PAKETPREIS
515.1270 PRIX FORFAIT
515.1270 PAKKETPRIJS

516.2042

ERGOTORQUE® basic Drehmomentschlüssel mit Drehknopf-Umsteck-Ratschenkopf
Clés dynamométriques ERGOTORQUE® basic
ERGOTORQUE® basic Momentsleutel met draaiknop-omsteek-ratelkop



1/2"

20-200 N.m



+3%

NEU



150.4325

SMD-Inspektions-Lampe 6 + 1
Lampe d'inspection à LEDs 6 + 1
SMD inspeclamp 6 + 1



170 mm

6+1 POWER SMD

IP X3
6+1 SMD x
6 SMD 40 LM
1 SMD 12 LM
40+70 °C
3xAAA
ECO

150.4375

Mobile LED POWER STRIPE
Werkstatt-Handlampe
Baladeuse à LEDs POWER STRIPE
Mobile LED POWER STRIPE
looplamp



65 mm

3 WATT POWER LED

IP 20
200 Lumen
3 x 3 W LED
3 W Stripe LED
3 h
5/-45 °C
3xAAA
BOOST

550.1238

LEDMAX CREE Power LED
Kopflampe mit Fokus
Lampe frontale LEDMAX
CREE-Power
LEDMAX CREE-Power LED
hoofdlamp met focus



65 mm

ree-Power

IP X3
3 W
100 Lumen Cree LED
1.5 - 2 h
<100.000 h
3xAAA
Ø 27,9 mm
112 g
ECO
BOOST

150.4405

Mobile LED POWER STRIPE
Werkstatt-Handlampe, knickbar
Lampe d'atelier mobile
LED POWER STRIPE, rabattable
Mobile LED POWER STRIPE
looplamp, buigbaar



227 mm

3 WATT POWER LED

IP 20
200 Lumen
1 x 1 W LED
3 W Stripe LED
3 h
5/-45 °C
3xAAA
ECO
BOOST

Karosserie und Innenausstattung
Carrosserie et garniture intérieure
Carrosserie en interieuruitrusting

140.2370 Clip-Löse-Satz
Jeu d'outils à dégrafer
Clip-verwijderset

6
 100% nieuw

510 mm

245 mm

2 x 4 mm
 2 x 8 mm
 2 x 10 mm

140.2325 Clip-Löser U-Form
Dégrafer de clips en forme de U
Clipverwijderaar, U-model

CrV

173 mm

5 mm

robust conception
 robuste
 robuust

140.2199 Motorhauben- und Heckklappenstütze
Barre de maintien de hayon
Motorkap- en achterklepsteun

1500 mm

960.1190 Heißluftgebläsepistolen-Satz
Jeu pour pistolets à propulsion d'air chaud
Heteluchtpistool set

220/240V (50/60HZ) 8A

5
 100% nieuw

2000 WATT

1= 50°C
 2= 100°C
 3= 200°C
 4= 350°C
 5= 550°C
 6= 650°C

①=50-450°C / 200-300L/min
 ②=50-650°C / 350-500L/min

960.1120 Kunststoff-Schweißkolben
Fer à souder pour matière plastique
Soldeerbout voor kunststof onderdelen

260 mm

15x26 mm

60 W 220V/240V 50-60HZ 13 A 0-400°C 1,35 m 960 g

OPTIONAL
 5
 100% nieuw
 960.1126

PP/EPDM, PE, TPO, TPE, TPV, TPUR, PE
 PUR, RIM, RRIM, EEBB, EMA

OPTIONAL
 960.1122 PE
 960.1123 PP
 960.1124 TPO
 960.1125 ABS

150.1035 Kunststoffreparatur-Satz (kabellos)
Kit de réparation pour plastique (sans fil)
Kunststofreparatieset (draadloos)

KABELLOS (AKKU) FÜR BIS ZU 150 KLAMMERN MIT EINER AKKULADUNG

302
 100% nieuw

DC 5V 2A 3,7V max 8A

45° max. 200°C

400 g 1300 g 3-4 h ~150x

100x Ø 0,6 mm 100x Ø 0,8 mm 100x Ø 0,6 mm 1x

SANS FIL (ACCU) POUR UN MAXIMUM DE 150 AGRAPES AVEC UNE CHARGE COMPLÈTE

ORIGINAALDS (ACCU) VOOR MAXIMAAL 150 NIELEN OP EEN AKKULADUNG

140.2599 Dellensegel
Kit de réparation pour bosses de carrosserie
Deukenpiegel

Ø 800 mm

140.2550 Lochstanzen-Satz für Abstandssensoren (PDC)
Jeu de poinçonneuses pour capteurs de distance (PDC)
Set gatpensen voor afstandssensoren (PDC)

20
 100% nieuw

VW, BMW ✓
 Ø 18,2 mm
 Opel ✓
 Ø 24,0 mm
 VW ✓
 Ø 26,0 mm
 BMW ✓
 Ø 32,0 mm

Skoda ✓
 Ø 18,0 mm

Skoda ✓
 Ø 26,7 mm

150.8110 Scheinwerfer-Einstell-Schlüssel Mercedes
Clé de réglage pour optique Mercedes
Afstelsleutel koplampen Mercedes

3/8" CrV

14 mm

195 mm

Mercedes C-Klasse (205) 2014 → ✓

150.8105 Scheinwerfer-Einstell-Schlüssel Audi
Clé de réglage pour optique Audi
Afstelsleutel koplampen Audi

CrV

Audi A4 (8K) ✓
 Audi A6 (4G) ✓
 Audi A5 (8T) ✓

345 mm



150.9650 Kunststoff-Nietzangen-Satz mit Nieten
Jeu de pinces à rivets en plastique, avec rivets
 Set kunststof nietzangen met nieten

- 150.9652 10x Ø6,6 mm x 17,2 mm
- 150.9653 10x Ø6,3 mm x 25,2 mm
- 150.9654 10x Ø5,0 mm x 17,2 mm
- 150.9655 10x Ø5,0 mm x 15,8 mm



41
100% Kunststoff

140.2162 Karosserie-Trennmeißel
Burin de carrossier
 Carrosserie-sleufbeitel

DIN 7255 CrV

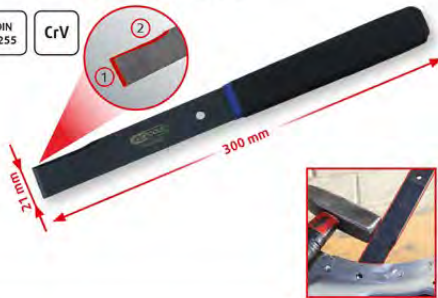

Elektronischer Überspannungsschutz
Protection contre les tensions électroniques
 Piekspanningsbeveiliging

Max 200A (8/20 µs)



150.3080	12 V	480
150.3045	12/24V	480

310.0180 Schweißerschutzhelm
Casque de soudeur
 Lasmasker

- 510
- DIN 9-13
- UV 155
- 100 37V 12/21



- MMA
- MAG/MIG
- TIG (WIG)



118.0050 Hebel-Blechdurchgangsscheren-Satz
Jeu de cisailles à tôles
 Blikscharenset



3
100% Kunststoff

115.1105 Mini-Karosserieklammern-Satz
Jeu de mini-pinces de carrosserie
 Mini-carrosserieklammernset

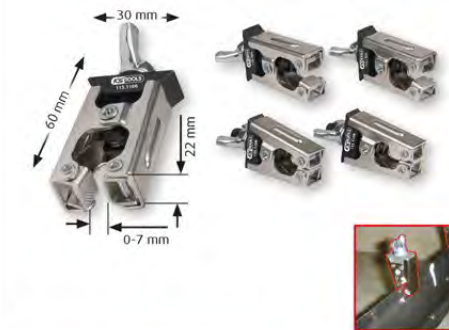

4
100% Kunststoff

150.3010 Schichtdicken-Messgerät
Appareil de mesure de l'épaisseur de la peinture
 Lakdikte meter

- LCB
- 0-40 mks (0-100 µm)
- 3,1/2"
- 9V
- IP64 (EN61010-1:2012)
- 0-50°C (32-122°F)
- 105 x 148 x 42 mm
- 157 g



- Ferrous
- Non Ferrous

Power-Gripzange
Pince étau power
 Power griptang

GRIP Xtreme

CrV



	L mm		min	max	min	max
115.1196	175,0	7"	0,4"	1,57"	0	1,57"
			10 mm	40 mm	0	40 mm
115.1197	220	10"	0,55"	1,97"	0	1,97"
			14 mm	50 mm	0	50 mm

162.0215 Karosserie-Trennmeißel-Satz
Jeu de burins de carrossier extra-plats
 Set plaatstaalbeitels

25 mm CrV



3
100% Kunststoff

903.1040 Magnet-Protector-Satz
Jeu de protecteurs magnétiques
 Magnet-beschermingsset

U

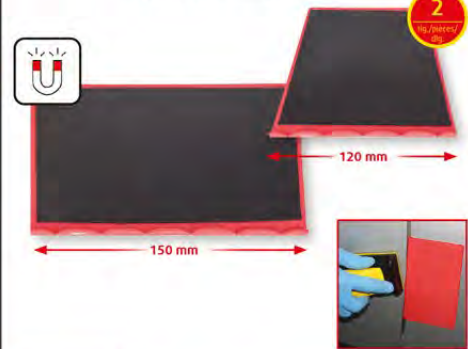

2
100% Kunststoff

500.1370 Radio und Navigationssystem Demontage und Montage-Satz
Coffret de montage/démontage pour autoradio
 Radio en navigatiesystemen de- en montageset

AM/FM/CD/NAV



18
100% Kunststoff

Audi, BMW, Ford, Mercedes, Opel, Porsche, Skoda, Volkswagen, Becker, Blaupunkt, Grundig

*Die angezeigten OE-Nummern dienen nur zur Zuordnung technischer Daten und der Verwendungszwecke.
 *Les numéros de série mettent en relation produits, caractéristiques techniques et utilisations.
 *De gemarkeerde OE nummers dienen uitsluitend voor de indeling van technische gegevens en de gebruiksdoelendoms.



Motor - Motorkühlsystem
 Moteur - Système de refroidissement moteur
 Motor - koelsysteem

700.1900 Wasserpumpen-DEMONTAGE-Werkzeugset für Volkswagen Diesel Motoren
 Coffret d'outils de démontage de pompes à eau Volkswagen
 Waterpomp demontage gereedschapset voor Volkswagen dieselmotoren

Volkswagen:
 T5 + Touareg 2,5 TDI +
 LT + Multivan



3
 10 Jahre / 100000 km

115.5055 Schlauch-Abklemm-Zangen-Satz, 90° abgewinkelt
 Jeux de pinces à clamper, coudées à 90°
 Afklemtangenset, 90 graden gebogen

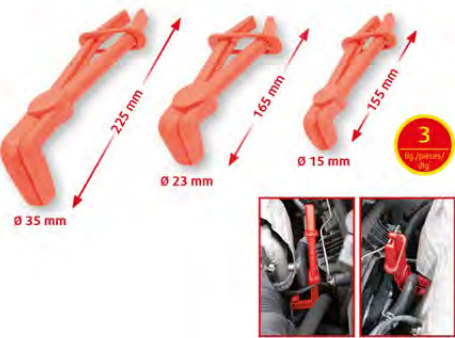

3
 10 Jahre / 100000 km

550.1285 Refraktometer - optisches Prüfgerät für Batterieflüssigkeit, Frostschutzmittel und AdBlue®-Zusätze (*)
 Réfractomètre - Appareil de contrôle optique pour liquide de batteries, liquide de refroidissement et additifs AdBlue® (*)
 Refractometer, tester voor accuvloeistof, antivries en AdBlue® toevoeging (*)



150.3040 Infrarot-Thermometer
 Thermomètre laser
 Infrarood-Thermometer



150.9020 Wasserpumpentester-Satz
 Testeur de pompe à eau
 Waterpomp testgereedschapset



8
 10 Jahre / 100000 km



Kühlmittel-Fluss / Leckagen / Luft im System / Verstopfungen etc.
 Flux de liquide de réfrigérant / fuites / air dans le système / colmatages etc.
 Koelvloeistofstroom / lekkages / lucht in het systeem / verstoppingen, enz.

150.3026 Halteschlüssel für Wasserpumpen-Riemenscheibe
 Clé de blocage pour poulie de pompe à eau
 Blokkeersleutel voor waterpomppeolies



Audi, Volkswagen etc.

150.3028 Riemenscheiben-Halteschlüssel, Typ 3
 Clé de blocage pour pompes à eau, type 3
 Riempeolie-sleutel, Typ 3



Audi, Volkswagen etc.

150.9239 Wasserkanne
 Aiguière d'eau
 Watervulkan



9 L

150.1930 MASTER Kühlsystem-Diagnose-Service-Satz
 Coffret de diagnostic pour système de refroidissement
 Koelsysteem-test en serviceset



25
 10 Jahre / 100000 km

Druck prüfen / Füllen
 Vérifier la pression / Remplir
 Drukcontroleren / vullen

150.9361 Ölauffangwanne 17 Liter
 Bac de récupération d'huile 17 litres
 Olie-opvangbak 17 Liter



17 L

150.2123 Thermocontact-Stecknuss
 Douille pour thermocontact
 Thermoschakelaar-dopsleutel





Motor - Kraftstoffanlage
Moteur - Système d'alimentation carburant
Motor - brandstofsysteem

115.1199 Schlauchlösezange
Pince pour tuyaux
Verstelbare slangklemtang



115.1045 Click-Schlauchschellenzange, geschmiedet
Pince pour collier
Click-slangklemtang, gesmeed



115.1094 Kraftstoffleitungs-
Pince pour conduites de carburant
Brandstofleidingtang



115.1060 Kraftstoffleitungs-Zange mit Bowdenzug
für Schnellkupplungen
Pince à collier à câble
pour raccords rapides
Brandstofleidingtang met
bowdenkabel voor
snelkoppelingen



115.0901 Schlauchschellenzange mit Bowdenzug
Pince avec câble Bowden pour
colliers auto-serrants
Slangklemtang met half
starre verlengkabel

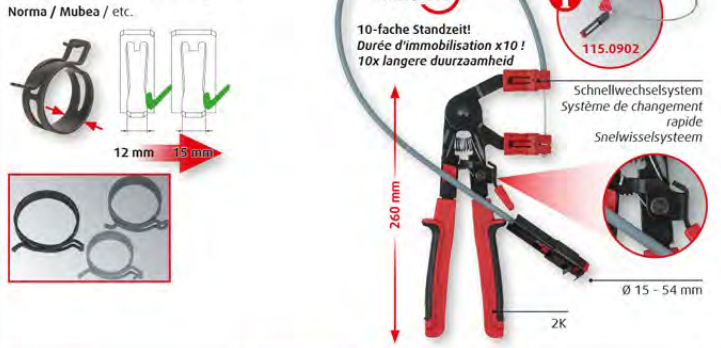

150.9388 3-Arm Universal-Tankgeberschlüssel
Clé pour trappe de réservoir à 3 bras
3 armige, universele tanksensorsleutel



150.3126 Kraftstofffilter-Montagehebel für
UFI Kraftstofffilterdeckel
Levier de montage de filtres à carburant pour
les bouchons-filtres à carburant UFI
Montagehefboom voor UFI brandstoffilterdeksels



150.1660 Umfüllpumpe
Pompe de transvasage
Multifunctionele 3 in 1 pomp



115.1008 Kraftstoffleitungs-Zange für Schnellkupplungen
Pince pour raccords rapides de conduites
de carburant
Brandstofleidingtang voor snelkoppelingen



150.9030 Diesel-Entlüftungs-/Vorbefüllungs-Satz
Coffret pour purge moteur diesel
Ontluchtings-/vulgereedschap
voor dieselmotoren

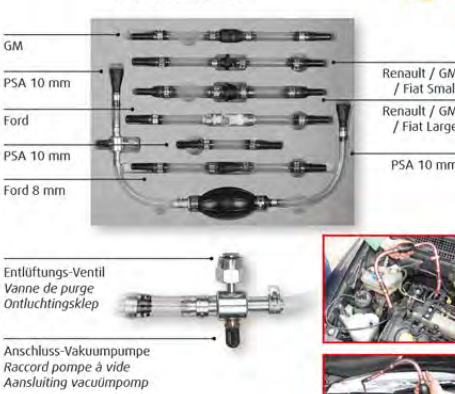

115.1099 Kraftstoffleitungs-
Pince pour conduites de carburant
coudée
Brandstofleidingtang, gebogen



*Die angezeigten OE-Nummern dienen nur zur Zuordnung technischer Daten und der Verwendungszwecke.
*Les numéros de série mettent en relation produits, caractéristiques techniques et utilisations.
*De gemarkeerde OE nummers dienen uitsluitend voor de indeling van technische gegevens en de gebruiksdoelend.



Motor - Zylinderkopf / Motorblock
Moteur - Culasse / bloc moteur
Motor - cilinderkop / motorblok

911.0470 Bit-Stecknuss- und Winkelstiftschlüssel-Satz für Fünfstern-Schrauben mit Stirnlochbohrung
Jeu douilles de tournevis 5 pans percé
 Set inbussleutels en dopsleutels met boring voor 5-kant inbusschroeven



⊙ TS10 - TS15 - TS20 - TS25 - TS27 - TS30 - TS40

Steuergeräte, Lichtmaschine, Luftmengenmesser, Außenspiegel, Steckpumpen bei Pumpe-Leitung-Düsen-System, Türschlossbefestigungsschrauben
 Calculateurs moteur, alternateur, débitmètres d'air, rétroviseurs extérieurs, pompes enfichables système buses-conduites, vis de fixation pour verrou de porte
 Regeleenheden, dynamo, luchthoeveelheidmeter, buitenspiegel, pomp bij pomp-leiding inspuitsysteem, portierslotbevestigingsschroeven
 Volkswagen, Audi, Ford, Mercedes, Rover, Seat, Skoda, Volvo etc.



158.8050 ERGOTORQUEplus® TX T-Griff-Stiftschlüssel-Satz
Jeu de clés mâles TX poignée en T ERGOTORQUEplus®
 ERGOTORQUEplus® T-greep-stiftsleutelset TX



373 mm

- T10 ✓
- T15 ✓
- T20 ✓
- T25 ✓
- T27 ✓
- T30 ✓

150.1650 Digitales Kompressions-Druckprüfgerät für Benzinmotoren
Compressiomètre et testeur d'étanchéité de cylindre - Essence
 Digitale compressiemeter voor benzinemotoren



- M10x1,0 ✓
- M12x1,25 ✓
- M14x1,25 ✓
- M18x1,5 ✓

911.4460 Zylinderkopf-Schrauben-Steckschlüssel-Satz
Jeu de clé à douilles pour vis de culasse
 Cilinderkopbouten-dopsleutelset



- ⊙ M9 - M9/M10 - M10 - M12
- ⊙ M12 - M13 - M14
- ★ E12 - E14
- ⊙ T55 - T70

150.1173 Teileablage für Zylinderkopf-Komponenten
Pour poser les pièces des composants de la culasse
 Opbergbak voor cilinderkoponderdelen

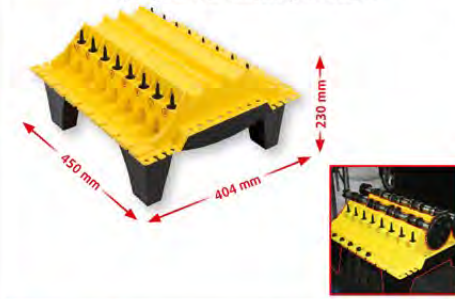

150.1780 Zylinder-Druckverlust-Tester
Testeur de perte de pression de cylindre
 Cilinder-drukverlies tester



Diagnose von Kompressions-Druckverlust
 - Ein- und Auslassventil
 - Kolbenringe oder Zylinderlaufbuchse
 - Zylinderkopf oder Dichtungung
Diagnostic de perte de pression de compression
 - Soupape d'admission et d'échappement
 - Segments de piston ou chemises de cylindres
 - Tête de cylindre ou étanchéité de tête
Diagnose van compressie-drukverlies
 - In- en uitlaatventiel
 - zuigerringen of cilindervoering
 - cilinderkop of koppakking

		mm	
1 x			0-7 bar / 0-100 psi
3 x		25	M10x1,0 / M12x1,25 / M14x1,25
1 x		40	M14x1,25
2 x		220	M12x1,25 / M14x1,25
1 x		470	
1 x		670	M14x1,25 + M18x1,5

152.2030 Kompressionsprüfer-Satz, digital
Jeu d'outils de contrôle de compression, digital
 Digitale compressietester, set



- ⊙ 0-20 bar / 0-20 bar / psi
- ⊙ 9V
- M10x1,00 ✓
- M12x1,25 ✓
- M14x1,25 ✓
- M18x1,50 ✓

907.2230 Dichtungsschaber-Satz
Coffret de grattoirs emmanchés désaxés
 Pakkingschraper set

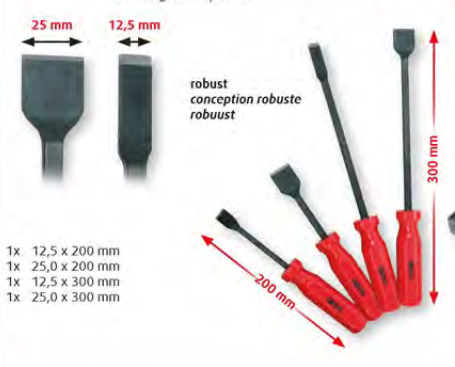

- 1x 12,5 x 200 mm
- 1x 25,0 x 200 mm
- 1x 12,5 x 300 mm
- 1x 25,0 x 300 mm

911.3120 TX PLUS Steckschlüssel-Satz
Jeu de clés à douilles TX PLUS
 TX-PLUS Dopsleutelset



- 1/4" 9/16"
- 1/4" ⊙ TS10 - TS15 - TS20 - TS25 - TS30
- 10 mm ⊙ TS40 - TS45 - TS50 - TS55 - TS60
- 1/4" ⊙ IP10 - IP15 - IP20 - IP25 - IP30
- 10 mm ⊙ IP40 - IP45 - IP50 - IP55 - IP60

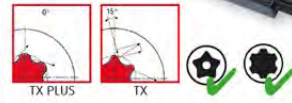

700.1280 Universal Wellendichtring und Simmerring Montagewerkzeug-Satz
Kit de montage outils bagues d'étanchéité universelles et système S.P.I
 Universele afdichting en keerring montage set



158.5050 ERGOTORQUEplus® T-Griff RIBE Winkelstiftschlüssel-Satz, extra lang
Jeu de clés mâles, poignée en T RIBE ERGOTORQUEplus® extra-longue
 ERGOTORQUEplus® T-greep RIBE inbussleutelset, extra lang

- M4 ✓
- M5 ✓
- M6 ✓
- M7 ✓
- M8 ✓
- M9 ✓
- M10 ✓



Alfa Romeo, Fiat, Lancia etc.



150.1920 Öldruck-Prüfgerät
Jauge de pression d'huile avec adaptateur
Oliedruktester inclusief adapter



- 1 x R1/8" 23
- 1 x 1/8" x 27 NPT 24
- 1 x 1/4" x 18 NPT 33
- 1 x 3/8" x 20 UNF 23
- 1 x 1/2" x 20 UNF 27
- 1 x M10 x 1,0 24
- 1 x M12 x 1,5 24
- 1 x M14 x 1,5 29
- 1 x M16 x 1,5 33
- 1 x M18 x 1,5



12
12 (personen)
12

150.1305 Gewindeausdreh-Satz
Jeu d'extracteurs
Schroefdraad-uitdraaiset

M5 → M16 ✓

- 5 x Ø 3,2 - 4,8 - 6,4 - 8,0 - 8,7 mm
- 10 x Ø 4,0 - 4,8 - 4,8 - 4,8 - 6,0 - 7,1 - 7,1 - 7,1 - 9,2 - 9,5 mm
- 5 x Ø 3,2 - 4,8 - 6,4 - 8,0 - 8,7 mm
- 5 x Ø SW 10 - 11 - 13 - 14 - 17 mm

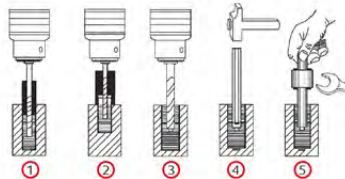

25
25 (personen)
25

Motor - Turbolader
Moteur - Turbo
Motor - turbocompressor

150.1825 Turbolader-Bajonett-Ladeluft-System-Prüfkoffer-Satz
Coffret de test à baïonnette du système d'air du turbocompresseur
Turbo druk testerset met bajonetadapter in koffer



- Ø 31 mm Ø 51 mm
- Ø 38 mm Ø 56 mm
- Ø 46 mm Ø 61 mm

max. 1,8bar



13
13 (personen)
13

550.7049-2014 ULTIMATEvision Videoskop-Satz
Kit Vidéoscope ULTIMATEvision Ø 4,9 mm
avec caméra double et extracteur vidéo
ULTIMATEvision videoscoopset



Video-Grabber
Vidéo benne preneuse
Video-Grabber



150.1900 KFZ Druck- und Unterdruckpumpen-Satz
Coffret de pompe à pression et dépression
Over en onderdruppompset



7
7 (personen)
7

Motor - Einspritzsystem
Moteur - Système d'injection
Motor - inspuitsysteem

152.1370 Injektorenschacht-Reinigungs-Satz
Kit de nettoyage du puit d'injection
Injectorschacht reinigungsset

1/4" / 6,3 mm



- Delphi ✓
- Bosch ✓
- Siemens ✓



23
23 (personen)
23

152.1183 Injektor-Dichtring-Auszieher
mit Schlaggewicht
Extracteur de joints d'injecteurs
avec masse à inertie
Trekker met slaggewicht voor
verstuiver-afdichtingen



340.0010 MASTER Reinigungs-Bürsten-Satz
Jeu de brosses de nettoyage MASTER
Master reinigungsborstelsset

- Ø 8 - 9 - 10 -
- 11 - 12 - 13 -
- 14 - 15 - 16 -
- 17 - 18 - 19 mm

1/4" / 6,3 mm



38
38 (personen)
38

150.2520 Turbolader-Ladeluft-System-Prüfkoffer-Satz
Coffret de test du système d'air du turbo
Turbo druk testerset in koffer



- Ø 31 x 38 mm Ø 75 x 80 mm
- Ø 46 x 51 mm Ø 85 x 90 mm
- Ø 55 x 60 mm Ø 95 x 100 mm
- Ø 65 x 70 mm Ø 105 x 110 mm

max. 1,8bar



17
17 (personen)
17

SIEMENS - DENSO - DELPHI - BOSCH - UNIVERSAL

152.1450 Druckluft-Meißel-Injektoren-Auszieh-Satz
Coffret d'extracteurs d'injecteurs de burins
pneumatiques
Pneumatische beitel injectorentrekkereset

520 mm

- A M25x1 Siemens
- B M20x1 Denso Nissan
- C M27x1 Siemens
- D M27/M17/+ 10 mm Bosch Fiat/BMW/PSA/ Mercedes/Renault
- E M12 Universal
- F M14 Bosch/Delphi Ford/Kia/Renault/PSA



10
10 (personen)
10

152.1380 Bosch-Einspritzpumpen-Stecknuss-Satz
 Jeu de douilles pour pompes à injection Bosch
 Doppnset Bosch inspuitspompn

2 10 Jahre / 800 km

13 mm
 CrV

7,8 mm: Bosch VP37 EDC 96-03 (TDI)
 13,5 mm: Bosch VE

Bosch *OE 0986612605
 Bosch *OE 098661750

152.1350 Injektor-Düsen-Auszieher-Satz für VAG
 Jeu d'extracteurs d'injecteurs pour VAG
 Set demontagegereedschap FSI-verstuivers

24 10 Jahre / 800 km

*OE: T101339 / T10155 / T1013318 / T101331 / T10163 / T100552 / T101332A / T10055 / T100551 / T101336 / T101337 / T101338 / T101335 / T100553 / T10133/11-15 / T10402 / T10133/10

FSI ✓
 SDI ✓
 TDI ✓
 CR ✓
 PD ✓

DISEL PATROL Audi / VW / Seat / Skoda

Motor - Zündkerzen
 Moteur - Bougies d'allumage
 Motor - bougies

911.3999 Spezial-Zündkerzen-Stecknuss mit Gelenk
 Douilles spéciales articulées à bougies
 Speciale bougie-dopsleutel met gewricht

3/8"
 14 mm

59 mm

BMW 1er (E81 / E87), 3er (E90), 5er (E60) N43

152.1170 Injektoren-Dichtsitz-Reinigungs-Satz
 Kit de nettoyage pour sièges d'injecteurs
 Injektor-brandplaat-reinigingsset

13 10 Jahre / 800 km

1 Dichtflächen-Reiniger
 Nettoyant pour surfaces d'étanchéité
 Afichtvlakreiner

2 Dichtung-Auszieher
 Extracteur bague d'étanchéité
 Afichtingtrekker

3 Dichtsitzfräser ● 13,0 mm
 Fraiseuse avec siège d'étanchéité ● 13,0 mm
 Afichtvakraeser ● 13,0 mm

4 3/8" Fräskopf-Pilot ● 19,0 mm
 3/8" tête fraisée-pilote ● 19,0 mm
 3/8" freeskop-pilot ● 19,0 mm

5 1/2" T-Griff Schlüssel für Fräskopfaufnahme
 1/2" Poignée en T Clé pour réception tête fraisée
 1/2" T-greep sleutel voor freeskophouder

6 Fiat Dichtsitzfräskopf Ø 15/19 mm
 Fiat tête fraisée avec siège d'étanchéité Ø 15/19 mm
 Fiat afichtvakraeskop Ø 15/19 mm

7 BMW / PSA / Renault Dichtsitzfräskopf Ø 17/17 mm
 BMW / PSA / Renault tête fraisée avec siège d'étanchéité Ø 17/17 mm
 BMW / PSA / Renault afichtvakraeskop Ø 17/17 mm

8 Mercedes Dichtsitzfräskopf Ø 17/19 mm
 Mercedes tête fraisée avec siège d'étanchéité Ø 17/19 mm
 Mercedes afichtvakraeskop Ø 17/19 mm

9 Fiat / Iveco Dichtsitzfräskopf Ø 19/21 mm
 Fiat / Iveco tête fraisée avec siège d'étanchéité Ø 19/21 mm
 Fiat / Iveco afichtvakraeskop Ø 19/21 mm

10 Innensechskantschüssel 2,5 mm
 clé Allen 2,5 mm
 Binnenzekantsleutel 2,5 mm

11 Nylon-Fräskopf-Reinigungsbürste
 Tête fraisée en nylon-brosse de nettoyage
 Nylon reinigingsborstel voor freeskoppen

12 Reinigungsbürste für Injektorenzapfenbohrung
 Brosse de nettoyage pour alesages et touillons d'injecteurs
 Reinigingsborstel voor verstuiverboringen

YouTube

Glühkerzenstecker-Zange
 Pince pour câble de bougie
 Gloeibougjestekker-tang

1 **2**

L2
 A
 L1

	A mm	L1 mm	L2 mm	1
500.7330	0 - 125	265,0	95,0	400
500.7310	0 - 105	235,0	120,0	400

500.7560 T-Griff-Zündspulen-Abzieher-Satz für VAG Motoren
 Jeu de Poignées en T pour extraction bobines d'allumage sur moteurs VAG
 Set bobinetrekkers met T-greep voor VAG-motoren

4 10 Jahre / 800 km

CrV

*OE T10094A
 *OE T10095A
 *OE T10166
 *OE T40039

Motor - Glühkerzen
 Moteur - Bougies de préchauffage
 Motor - gloeibougies

152.1120 MASTER 3 in 1 Glühkerzen-Reibahlen-Satz
 Coffret Master alésoir 3 en 1
 MASTER 3 in 1 gloeibougies ruimerset

9 10 Jahre / 800 km

M 8x1,00
 M10x1,00
 M10x1,25
 M12x1,25

Glühkerzenbohrer / Logement de bougie à incandescence / Preheating plug drill / Logement de bougie à incandescence

Dichtsitzbohrer / Logement d'étanchéité / Sealant drill / Logement d'étanchéité

Heizkerzenbohrer / Logement de thermoplongeur / Preheating glow plug drill / Logement de thermoplongeur

150.1516 Zündmodul-Abzieher-Satz
 Coffret d'extracteurs de module d'allumage
 Set trekkers voor ontstekingsmodules

2 10 Jahre / 800 km

max. 8 Nm

Chevrolet, Vauxhall/Opel 3 + 4 Zyl. 1.0, 1.2, 1.4, 1.6, 1.8, 2.0, 2.2 Petrol, Fiat Croma 1,8 l, Alfa-Romeo 159 1,8 l

500.7320 Glühkerzen-Gelenkschlüssel-Satz, lang
 Module de douilles articulées pour bougies de préchauffage, longues
 Gloeibougiedopset met kniegewricht, lang

6 10 Jahre / 800 km

3/8"

8 mm ✓
 9 mm ✓
 10 mm ✓
 12 mm ✓
 14 mm ✓
 16 mm ✓

150 mm



Motor - Hilfsriemen / Lichtmaschine
Moteur - Courroies accessoires / alternateur
Motor - aandrijfriemen / dynamo

150.3194 Universal-Riemenscheiben-Abzieher 3-armig
 Extracteur universel de poulies de courroie à trois griffes
 Universele-riemschijftrekker 3-armig

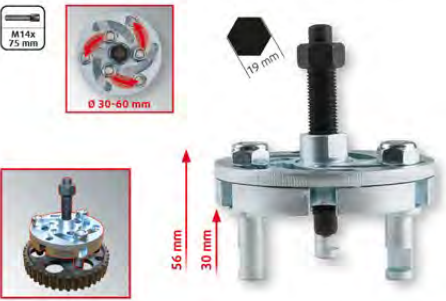

150.3152 Universal-Gegenhalter für Keilrippenriemenscheiben
 Contre-supports pour poulies de courroies de distribution
 Tegenhouder voor multiriem-poulies



150.3150 Universal-Gegenhalter für Keilriemenscheiben
 Contre-supports pour poulies de courroie de distribution
 Tegenhouder voor V-riem-poulies



HÖCHSTE TYPEN-ABDECKUNG

150.3180 Elastrriemen-Spezialwerkzeug-Satz
 Jeu d'outils spéciaux pour courroies élastiques
 Set speciaal gereedschap voor Elast riemen



150.1200 Universal Keil- und Zahnriemen-Schlüssel-Satz
 Jeu de clés pour poulies
 Multi- en tandriem-spanrolsleutelset



150.2990 Universal Arretierwerkzeug / Gegenhalter für Nockenwellenräder
 Outil de blocage d'arbres à cames - Universel
 Poelie blokkeerset



150.3165 Elektronischer Riemenspannungs-Prüfer
 Contrôleur électronique de tension de courroies HZ
 Elektronische Riemspringstester



150.3170 Universal-Riemenscheiben-Abzieher 2-armig
 Extracteur universel de poulies de courroie à deux griffes
 Universele-riemschijftrekker 2-armig



518.0850 CHROMEplus® Starter- und Blockschlüssel-Satz
 Jeu de clés polygonales demi-lune CHROMEplus®
 CHROMEplus® Startersleutelset



150.1645 Mechaniker-Stethoskop
 Stéthoscope de mécanicien
 Monteurs-stethoscoop



150.3000 Universal Riemenscheiben-Gegenhalter-Schlüssel-Satz
 Jeu de leviers de blocage de poulie - Universel
 Universele-poulie blokkeerset



Motoreinstellwerkzeuge
Outils de calage moteur
Afstelgereedschap voor motoren

150.3190 Universal-Nockenwellen Blockiervorrichtung
 Outil de blocage de double arbre à cames - Universel
 Universele nokkenas blokkeerinrichting



*Die angezeigten OE-Nummern dienen nur zur Zuordnung technischer Daten und der Verwendungszwecke.
 *Les numéros de série mettent en relation produits, caractéristiques techniques et utilisations.
 *De gemarkeerde OE nummers dienen uitsluitend voor de indeling van technische gegevens en de gebruikdoeleinden.

400.1400 VAG - Motoreinstell-Werkzeug-Satz
Jeu d'outils de calage moteur - VAG
 Timingtoolset - VAG

Anwendungen: / Applications: /
 Toepassingen:
 VAG + FSI/TFSi

35 10 Jahre / 10 ans



400.2200 VAG - Motoreinstell-Werkzeug-Satz
Jeu d'outils de calage moteur - VAG
 Timingtoolset - VAG

Anwendungen: / Applications: /
 Toepassingen:
 Petrol - 1,4L / 1,6L FSI
 1,4L TSI

7 10 Jahre / 10 ans



400.1050 BMW - Motoreinstell-Werkzeug-Satz
Jeu d'outils de calage moteur - BMW
 Timingtoolset - BMW

Anwendungen: / Applications: /
 Toepassingen:
 Petrol - 1,6L / 1,8L / 2,0L
 MG: M42 / N42 / N46

10 10 Jahre / 10 ans



400.2225 VAG - Motoreinstell-Werkzeug-Satz
Jeu d'outils de calage moteur - VAG
 Timingtoolset - VAG

Anwendungen: / Applications: /
 Toepassingen:
 Petrol - 1,4L / 1,6L / 1,8L Turbo
 2,0L / 2,2L / 2,3L /
 2,6L / 2,8L
 1,8L / 2,0L - 16V
 Diesel - 1,0L / 1,2L / 1,3L /
 1,4L / 1,9L - TDI
 1,7L / 1,9L - SDI
 2,5L - TDI / 2,8L - 30V

19 10 Jahre / 10 ans



400.3300 VAG - Motoreinstell-Werkzeug-Satz
Jeu d'outils de calage moteur - VAG
 Timingtoolset - VAG

Anwendungen: / Applications: /
 Toepassingen:
 VW: 1,2 / 1,4 / 1,6 FSI/TFSi + TSI Petrol
 (1,2L - CBZA, CBZB, CBZC)
 (1,4/1,6L - BAG, BLF, BLG, BLP,
 BMV, BWK CAXA (03-))

8 10 Jahre / 10 ans



Audi: A3 Škoda: Fabia 2, Octavia 2,
 Roomster VW: Eos, Golf, Golf Estate,
 Golf Plus, Jetta, Passat, Polo, Tiguan,
 Touran.

400.3200 BMW - Motoreinstell-Werkzeug-Satz
Jeu d'outils de calage moteur - BMW
 Timingtoolset - BMW

Anwendungen: / Applications: /
 Toepassingen:
 BMW N43
 1.6+2.0 (06-),
 1-er 1.6 (07-10),
 1-er 2.0 (06-13), 3-er 2.0 (07-13),
 5-er 2.0 (07-10)

7 10 Jahre / 10 ans



N43 B20AY,
 N43 B20A+AA,
 N43 B16AA/00,
 N43 B20U0

400.1800 Renault - Motoreinstell-Werkzeug-Satz
Jeu d'outils de calage moteur - Renault
 Timingtoolset - Renault

Anwendungen: / Applications: /
 Toepassingen:
 Petrol - 1,2/1,4/1,7, 1,4/1,6/1,8/
 2,0 16v, 2,2 8v, 2,5 20v
 Diesel - 1,9 D/TD, 2,1/2,2 D/TD,
 2,5 D/TD, 2,8 D

18 10 Jahre / 10 ans



400.2700 VAG - Motoreinstell-Werkzeug-Satz
Jeu d'outils de calage moteur - VAG
 Timingtoolset - VAG

Anwendungen: / Applications: /
 Toepassingen:
 Diesel - VAG 1,4/1,9/2,0 TDI PD
 Ford Galaxy 1,9 TDI/TDI PD

7 10 Jahre / 10 ans



Audi:
 A3, A4, A6,
 Škoda:
 Octavia 2, Fabia,
 Volkswagen:
 Golf, Golf Plus, Jetta,
 Touran, Lupo, Fox, Bora,
 Beetle, Caddy, Sharan, Passat,
 Seat:
 Leon, Toledo,
 Althea, Alhambra

400.2300 VAG - Motoreinstell-Werkzeug-Satz
Jeu d'outils de calage moteur - VAG
 Timingtoolset - VAG

Anwendungen: / Applications: /
 Toepassingen:
 Petrol - 1,4L / 1,6L / 2,0L /
 2,4L / 3,2L FSI /
 2,0L TFSi

17 10 Jahre / 10 ans



Abgasanlage / Katalysatoren
Système d'échappement / catalyseurs
Uitlaatsystemen / katalysatoren

150.2100 Lambda-Sonden / ThermoSchalter /
Einspritzdüsen-Stecknuss-Satz
Jeu de douilles pour sondes lambda /
sondes thermiques / injecteurs
Lamda sensoren / thermoschakelaar /
verstuivers dopseutelsset

7 10 Jahre / 10 ans

3/8" 1/2"
 CrMo



Ø	mm	6/12	mm
3/8"x28 mm	1" + 1.1/16"	●	77
1/2"	29 mm	●	90
1/2"	27 mm	●	85
1/2"	22 mm	●	48
3/8"	22 mm	●	31
3/8"	22 mm	●	81
3/8"	22 mm	●	90

460.2513 AdBlue® Absaug- und Füllhandpumpe (*)
AdBlue® Pompe de remplissage et d'aspiration (*)
AdBlue® Metalen afzuig- en vulhandpomp (*)

540 mm
 Ø 12,5 x 410 mm

1,5L



Manuelles Absperventil
 Vanne d'arrêt à commande manuelle
 Handbediende afsluitklep

550.1288 Einweg-Befüllschlauch für AdBlue®-Zusätze -
tropffrei (*)
Tuyau de remplissage unidirectionnel pour
additifs AdBlue® - antigoutte (*)
Vulslang voor éénmalig gebruik voor AdBlue®
toevoeging, drupvrij (*)

1.000 mm

100% STOP



150.5090 THREADfix Reparatur-Satz M18 x 1,5
für Lamdasonden
Coffret de réparation pour sondes
Lambda THREADfix M18 x 1,5
THREADfixReparatieset M18 x 1,5 voor
lamdasensoren

9 10 Jahre / 10 ans



M18x1,5 x M20x1,5 x 9 mm

150.1545 Auspuffrohr-Trennwerkzeug
Outil de séparation de tuyau d'échappement
Uitlaatverbinding demontage-gereedschap

8 10 Jahre / 10 ans



M12x 1,75 mm
 3/8" 17mm
 Ø 25 mm - max. Ø 70 mm



Klimatechnik
Système de climatisation
Klimaatregeling

550.1180 UV-Lecksuchlampen-Satz
Jeu de lampes UV de détections de fuites
UV-lekzoeklamp, set



Einsatz mit handelsüblichen
Lecksuch-Additiven!

Utilisation avec des additifs de recherche
de fuites disponibles dans le commerce!
Gebruik met in de handel verkrijgbare
lekzoekadditiefen!



550.1192 Klimaanlage-Lecksuchgerät
Appareil de détection des fuites pour système
de climatisation
Lekdetector airconditioning

229 x 65
x 65 mm
R134a / R12 / R11 / R500 /
R503 / R22 / R123 / R124 /
R502 / R404a / R125 /
AZ-50 / HP62 / MP39

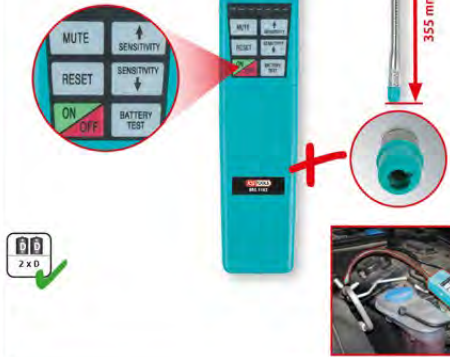

550.1183 Plasma-Luftreiniger mit Ionisator-Technik
Purificateur d'air plasma par ionisation
Plasma luchtreiniger met ionisatorstechnologie

173 x 122
x 49 mm
383 l/h
B10
5 mg/h
3.000.000
lede/cm²
max. 15m²
1-lit
e850ml/h
≤ 5 W



150.1963 Stab-Thermometer
Thermomètre
Thermometer



115.1260 MASTER Leitungsverbinde-Löseclip-Satz für
CLIC-Federverschluß-Leitungskupplungen
Coffret d'outils pour raccords de climatisation
Leiding-verbinding ontgrendelset



550.1710 12 V Batterie-Booster -
mobiles Starthilfegerät 700 A
Booster à batterie 12 V, 700 A
12 V Startbooster -
mobile starthulp 700 A

12 V
700 A
1 x 22 Ah
PEAK AMP
2200 A
10 kg
1,8 m
35 mm²
Automatic
12V / 4A



550.1720 12 V + 24 V Batterie-Booster -
mobiles Starthilfegerät 1400 A
Booster à batterie 12 V + 24 V, 1400 A
12 + 24 V Startbooster -
mobile starthulp 1400 A

12 / 24 V
1400 A
700 A
2 x 22 Ah
16 kg
1,8 m
35 mm²
Automatic
12V / 4A



550.1725 Batterie-Booster 12V + 24V - fahrbar 3000 A
Booster à batterie 12V + 24V - sur roue 3000 A
12 V + 24 V accubooter - mobil
starthulpoestel 3000 A

12 / 24 V
3000 A
1500 A
SLA
2 x 80 Ah
PEAK AMP
7500 A
3400 A
2 m
75 mm²
Automatic
12V / 6A
47 kg



550.1646 12V Digital-Batterie- und Ladesystemtester mit integriertem Drucker
Testeur de système de chargement et de batterie numérique 12 V avec imprimante intégrée
12V digital accu en laadsysteemtester met geïntegreerde printer

SAE 50 - 1.400 CCA
DIN 50 - 800 A
IEC 50 - 800 A
EN 50 - 1.400 A
CCA 50 - 1.400 CCA
MF
WET
AGM
VRLA
GEL
-18°C -
55°C
1,5 - 17V

OK 13.35V/15.5
V>15.5
V<13.3
OK V≥9.6
OK V<9.6
LICHTMASCHINEN-TEST
TEST D'ALTERNATEUR
DYNAMO-TEST
ANLASSER-TEST
TEST DE DÉMARREUR
STARTERTEST



*Die angezeigten OE-Nummern dienen nur zur Zuordnung technischer Daten und der Verwendungszwecke.

*Les numéros de série mettent en relation produits, caractéristiques techniques et utilisations.

*De gemarkeerde OE nummers dienen uitsluitend voor de indeling van technische gegevens en de gebruikdoelendes.



550.1730 12V SMARTCharger Hochfrequenz-Batterieladegerät 2A
 Chargeur de batteries haute fréquence
 SMARTCharger 12V - 2A
 SMARTCharger acculader 12V - 2A



				Ah
12V/2A	DC14,4V / 2A	AC220-240 50/60HZ	3	3 - 40

550.1735 6V + 12V Hochfrequenz-Batterieladegerät
 Chargeur de batteries hautes fréquences 6V et 12V
 6V + 12V High-Frequency acculader



				Ah
12V+6V / 4A	DC14,4V / 4A	AC220-240 50/60HZ	9	3 - 80

550.1745 12V + 24V SMARTCharger Hochfrequenz-Batterieladegerät 25A/12,5A
 Chargeur de batteries haute fréquence
 SMARTCharger 12V + 24V, 25A/12,5A
 SmartCharger Hoogfrequente acculader 12V + 24V, 25A/12,5A



				Ah
12V	DC14,4V / 25,0A	AC220-240V 50/60HZ	9	75-500
24V	DC28,8V / 12,5A	AC220-240V 50/60HZ	9	45-250

Elektrik- / Elektronikwerkzeuge
 Outils électriques / électroniques
 Gereedschap voor elektrika / elektronika

960.1160 Mikro-Löt-Satz
 Micro set de soudure
 Micro-soldeerset

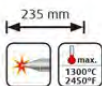

10
 10 Jahre Garantie

154.0140 PKW-Entriegelungswerkzeug-Satz für die neue Fahrzeuggeneration
 Jeu d'extracteurs de cosses pour la nouvelle génération de poids-lourds
 Set ontgrendelingsgereedschappen voor de nieuwe generatie personenauto's

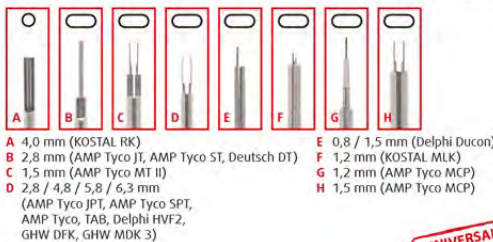

- A 4,0 mm (KOSTAL RK)
- B 2,8 mm (AMP Tyco JI, AMP Tyco ST, Deutsch DT)
- C 1,5 mm (AMP Tyco MT II)
- D 2,8 / 4,8 / 5,8 / 6,3 mm (AMP Tyco JPT, AMP Tyco SPT, AMP Tyco, TAB, Delphi HVF2, GHW DFK, GHW MDK 3)
- E 0,8 / 1,5 mm (Delphi Ducon)
- F 1,2 mm (KOSTAL MLK)
- G 1,2 mm (AMP Tyco MCP)
- H 1,5 mm (AMP Tyco MCP)

UNIVERSAL
 UNIVERSEEL



8
 10 Jahre Garantie

FÜR DIE NEUE FAHRZEUGGENERATION
 POUR LES MACHINES DE LA NOUVELLE GÉNÉRATION
 VOOR DE NIEUWE GENERATIE AUTO'S

154.0145 PKW-Entriegelungswerkzeug-Satz für die ältere Fahrzeuggeneration
 Jeu d'extracteurs de cosses pour ancienne génération de voitures
 Set ontgrendelingsgereedschappen voor de oude generatie personenauto's

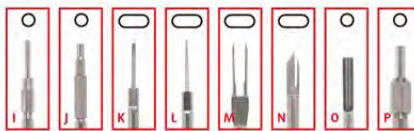

- I 1,5 mm (AMP Tyco 1,5)
- J 1,5 mm (KOSTAL LKS)
- K 1,5 mm (AMP Tyco Superseal)
- L 1,6 mm (AMP Tyco MT I)
- M 9,5 mm (AMP Tyco MPT)
- N 6,3 mm (GHW 6,3)
- O 4,0 mm (KOSTAL RK)
- P 3,5 mm (AMP Tyco 3,5)

UNIVERSAL
 UNIVERSEEL



8
 10 Jahre Garantie

FÜR DIE ÄLTERE FAHRZEUGGENERATION
 POUR LES MACHINES DE L'ANCIENNE GÉNÉRATION
 VOOR DE OUDERE GENERATIE AUTO'S

150.1495 Digital Multimeter inkl. Prüfspitzen
 Multimètre digital
 Digitale multimeter incl. testpennen



- V~ 200 mV → 600 V
- A~ 200 µA → 10 A
- V... 200 V → 600 V
- Ω 200 Ω → 2000 Ω

F = 200 mA/250 V
 (20 x 5 mm)



150.1675 12/24V Diagnose Prüf- und Mess-Kabel-Satz
 Jeu de câbles de mesure et de vérification pour diagnostic 12/24V
 12/24V Meet en teststekkerset



13
 10 Jahre Garantie

Universal Kabel-Entriegelungswerkzeug für Flachstecker und Flachsteckhülsen
 Extracteur universel de cosses pour connecteur plat et cosses Faston
 kabelontgrendelingsgereedschap voor platte stekkers en platte steckerhulzen



154.0011
 2,8 - 4,8 -
 5,8 - 6,3 mm

AMP Tyco JPT, AMP Tyco JI,
 AMP Tyco SPT, AMP Tyco ST

Universal Kabel-Entriegelungswerkzeug für Rundstecker und Rundsteckhülsen
 Extracteur universel de cosses pour connecteur plat et rond
 kabelontgrendelingsgereedschap voor ronde stekkers en ronde steckerbussen



154.0013
 1,5 - 3,5 mm

AMP Tyco CI2, AMP Tyco Mate-N-Lok,
 GHW RAM, GHW RSA2



154.0012
 1,6 mm

AMP Tyco MT I, AMP Tyco MT II



154.0112
 65 mm

Mercedes Sprinter
 VW Crafter > 2005
 *OE VAS 1978/35-17

GHW GSK





Getriebe
Boîte de vitesses
Versnellingsbakken / transmissies

GRÖSSTE MARKTABDECKUNG!

150.9275 Universal Getriebeöl-Füllsystem-Satz
inkl. 15-tlg. Adaptersatz
Système de remplissage universel de boîte de vitesses, 15 pcs Jeu d'adaptateurs
Vul- en aftapsysteem voor versnellingsbakolie met 15 delige adapterset



Inklusive Rücklauffunktion!
Fonction d'inversion incluse!
inclusief teruglooppunctie!

- 1x 1/8"-27 NPT Ford
- 1x BMW, Honda, Nissan ...
- 1x VAG
- 1x VAG, Porsche
- 1x M10 x 1.0 VAG, Mini Cooper
- 1x M24 x 1.5 VAG DSG
- 1x M22 x 1.5 VAG CVT
- 1x M12 x 1.5 Mercedes
- 1x M18 x 1.5 Skoda
- 1x M30 x 1.5 VAG, Skoda
- 1x Universal Flexible 300 mm, Honda, Hyundai, Kia, ...
- 1x 5/16"-24 (UNF) Volvo
- 1x M18 x 1.5 Toyota / Lexus
- 1x M8 x 1.0 Nissan / Infiniti
- 1x ATF-Adapter VW, Passat

16
16 pieces set



LA PLUS GRANDE COUVERTURE DU MARCHÉ!

GRÖSSTE MARKTABDECKUNG!

Kupplung
Embrayage
Koppeling

150.2105 SAC Kupplungswerkzeug-Satz (3-Loch Teilung)
Coffret pour embrayages de type SAC
(3 points de fixation)
SAC-koppeling-gereedschapset
(met 3 bevestigingspunten)

VAG / BMW / Mercedes / Opel / Renault / Volvo ...



150.2115



32
32 pieces set

150.2290 Kupplungs-Zentrier-Werkzeug-Satz
Ø 15,0 - 28,0 mm mit Zentrierhülsen
Jeu d'outils et entretoises de centrage Ø 15,0 - 28,0 mm
Centreergereedschap met centreerbussen voor koppelingen Ø15,0-28,0mm



Ø: 26-19-17-16-15-14-12-10 mm

UNIVERSAL
UNIVERSAL
UNIVERSEEL

11
11 pieces set

150.2390 Renault Kupplungs-Zentrier-Werkzeug-Satz
Ø 23,0 - 35,0 mm mit Zentrierhülsen
Jeu d'outils et entretoises de centrage Renault Ø 23,0 - 35,0 mm
Centreergereedschap met centreerbussen voor Renault koppelingen Ø23,0-35,0mm



Ø 23,0 mm

Ø 15,0 mm, Ø 16,0 mm, Ø 17,0 mm, Ø 18,0 mm, Ø 19,0 mm, Ø 20,0 mm, M8 x 1,25

9
9 pieces set

150.2380 Kupplungs-Zentrier-Werkzeug-Satz
Ø 24,0 - 36,0 mm mit Zentrierhülsen
Jeu d'outils et entretoises de centrage Ø 24,0 - 36,0 mm
Centreergereedschap met centreerbussen voor koppelingen Ø24,0-36,0mm



Ø 24,0 mm

Ø 15,0 mm, Ø 16,0 mm, Ø 17,0 mm, Ø 18,0 mm, Ø 19,0 mm, Ø 20,0 mm, M8 x 1,25

9
9 pieces set

700.1300 Universal-Abzieher-Satz
Coffret d'extracteurs universels
Universiele-trekkereset



12
12 pieces set

150.2439 Schwungrad-Blockierwerkzeug-Satz variabel
Jeu d'outils de blocage de volant moteur
Blokkeergereedschap vliegwiél, verstelbaar



6
6 pieces set

150.2425 Zweimassenschwungrad Prüfwerkzeug mit Winkelgradscheibe und Messuhr
Outil de contrôle pour volant bi-masse avec rapporteur et comparateur
Testgereedschap met gradenboog en micrometer voor dubbel massa vliegwielen



Freiwinkel prüfen über Zahnzahl
Vérifier l'angle de dépouille en fonction du nombre de dents
Vrije hoek controleren m.b.v. aantal tanden

Kippspiel prüfen
Vérifier le jeu de basculement
Kiepspeling controleren

Freiwinkel prüfen über Gradscheibe
Vérifier l'angle de dépouille à l'aide du rapporteur
Vrije hoek controleren m.b.v. gradenboog

UNIVERSAL
UNIVERSAL
UNIVERSEEL

17
17 pieces set

inklusive Messuhr und Drehwinkelmeßscheibe
avec cadran de contrôle à aiguille et disque de mesure d'angle
inclusief meetklok en gradenboog

150.2098 Ölfilterschlüssel für Haldex-Kupplungen
Clé de filtre à huile type Haldex
Oliefilter-sleutel voor Haldex-koppelingen



VW 4Motion
Audi Quattro

*OE VAG T10066

150.9202 Ölfilter-Schlüssel für DSG-Getriebeölwechsel für Common-Rail-Motoren, kurz
Filtre à huile clé pour vidange huile boîte DSG pour moteurs à rampe commune, petit modèle
Oliefiltersleutel voor olie verversen van DSG-versnellingsbakken voor Common-Rail motoren, kort



Audi, Seat, Skoda, Volkswagen

150.9353 Ölfilter-Schlüssel für DSG-Getriebeölwechsel, lang
Filtre à huile clé pour vidange huile boîte DSG, grand modèle
Oliefiltersleutel voor olie verversen van DSG-versnellingsbakken, lang



Audi, Seat, Skoda, Volkswagen

Feder / Stossdämpfer
Amortisseurs
Veren / schokdempers

150.1820 Sturzeinstellwerkzeug-Satz für BMW
Jeu d'outils de réglage de carrossage pour BMW
BMW-Camberafstelset



- 1er (E81, E82, E87, E88)
- 3er (E46, E90, E91, E92, E93)
- 5er (E39, E60, E61)
- 6er (E63, E64)
- 7er (E38, E65, E66, E67)
- X3 (E83)
- X5 (E53)
- Z4 (E85, E86)

3/2
3/2 pieces set

500.8700 Universal Federspanner-Satz
 Kit de compresseurs de ressorts universel
 Universele-veerspannerset



500.8610 Universal-Teleskop-Centerspanner-Satz
 Coffret compresseur universel de ressorts hélicoïdaux
 Universele-Telescoop centerspannerset



500.8805 Druckluft-Stand-Federspanner
 inkl. Adapterplatte
 Station fixe de compression de ressort
 d'amortisseur incl. adaptateur
 Pneumatische veerspanner
 incl. Adapterplaat



Lenkung und Lenkgeometrie
 Direction / géométrie
 Stuurinrichting en stuurgeometrie

150.1602 Verstellzange für Spurstangen
 Clé de réglage pour barre stabilisatrice
 Verstelbare tang voor spoorstangen

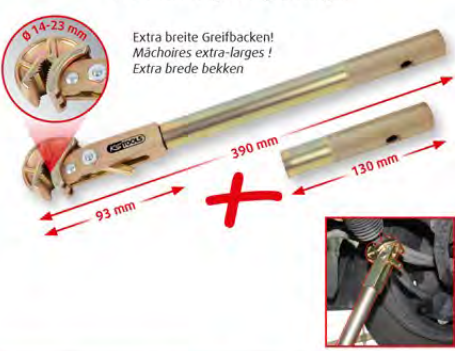

Universal-Kugelgelenk-Ausdrücker
 Arrache rotules universel
 Universele-trekker voor kogelgewrichten



	A mm	C mm	max t	Ø mm	mm
670.0111	18-22	50	3,5	19	M14x1,5x48

150.1695 Elektronisches Profi-Stethoskop
 Stéthoscope électronique
 Elektronische profi-stethoscoop



160.0095 Universal Motor-Stütztraversen-Satz
 Jeu de traverse support moteur universelle
 Universele motorsteun traveransen



700.1495 Universal-Achshebel mit Kette
 Levier d'essieu universel avec chaîne
 Universele ashefboom met ketting





440.0020 Druck- und Zug-Hydraulikzylinder-Satz, 8,5t
Coffret vis de force hydraulique, 8,5t
Hydraulische cilinder, 8,5t

max. 8,5t
4 15/16" (400 mm) 15/16" (400 mm)

G1/8"-28
25 mm
1.1/2"-11
M22
100 mm

106 mm

Kolbenrücklauf automatisch!
Retour de piston automatique!
Automatisch teruglopende zuiger!

1,8 kg

440.0015 Kurzhub-Hydraulikzylinder-Satz, 14t
Coffret de vis hydraulique à course réduite, 14t
Hydraulische cilinders met korte slag, 14t

max. 14t
3 15/16" (400 mm) 15/16" (400 mm)

G1/4"-19
1.1/2"-11
M24x3,0
92 mm

138 mm

Kolbenrücklauf automatisch!
Retour de piston automatique!
Automatisch teruglopende zuiger!

Ideal für Einsatz mit 440.0190 auf Seite 9!
Idéal pour une utilisation avec 440.0190 en page 9!
Idéal voor gebruik met 440.0190 op bladzijde 9!

2,5 kg

440.0005 Druck- und Zug-Hydraulikzylinder-Satz, 16t
Coffret vis de force hydraulique, 16t
Hydraulische cilinder, 16t

max. 16t
10 15/16" (400 mm) 15/16" (400 mm)

G1/4"-19
M22x2,5
1.1/2"-11
67 mm
166 mm

1 M18/M20 x 250 mm
2 M24 x 129,5 mm
3 M24 x 132 mm

3,4 kg

440.0010 Druck- und Zug-Hydraulikzylinder-Satz, 22t
Coffret vis de force hydraulique, 22t
Hydraulische cilinder, 22t

max. 22t
10 15/16" (400 mm) 15/16" (400 mm)

G1/4"-19
M22x2,5
1.1/2"-11
70 mm
202 mm

1 M18/M20 x 250 mm
2 M24x3,0 x 151 mm
3 M24x3,0 x 109 mm

Kolbenrücklauf automatisch!
Retour de piston automatique!
Automatisch teruglopende zuiger!

4,7 kg

440.0025 Druck- und Zug-Hydraulikzylinder-Satz, 32t
Coffret vis de force hydraulique, 32t
Hydraulische cilinder, 32t

max. 32t
6 15/16" (400 mm) 15/16" (400 mm)

G1/4"-19
M22x2,5
2.1/2"-11
113 mm
224,5 mm

1 M24 x 109 mm
2 M24 x 250 mm

OPTIONAL
440.0011

8,3 kg

440.0040 Zugstangen-, Kragenmutter-, Adapter-Satz
Jeu d'adaptateur de vis de force et d'écrou à embase
Set trekstangen, kraagmoeren en adapters

max. 13t
15/16" (400 mm) 15/16" (400 mm)

M10
M12
M14
M18/M22
M22

M10
M12
M14
M18
M22

250 mm

440.0475 Hydraulikzylinder-Halterung-Satz
Jeu de support de vérin hydraulique
Bevestigingsset hydraulische pomp

OPTIONAL
160.0327
160.0324

440.0015/440.0005
440.0010/440.0025

4 15/16" (400 mm) 15/16" (400 mm)

Ø 65-70 mm
Ø 70-85 mm
Ø 85-100 mm
Ø 25/30 mm

*Die angezeigten OE-Nummern dienen nur zur Zuordnung technischer Daten und der Verwendungszwecke.
*Les numéros de série mettent en relation produits, caractéristiques techniques et utilisations.
*De gemarkeerde OE nummers dienen uitsluitend voor de indeling van technische gegevens en de gebruikdoeleinden.

*Bei CEJN® handelt es sich um eine eingetragene Marke von Cejn AB, Skövde, Schweden.
*CEJN® est une marque déposée de Cejn AB, Skövde, Suède.
*CEJN® is een geregistreerd trademark van Cejn AB, Skövde, Zweden.



01.10.2016 - 31.03.2017

440.0055 Pneumatischer Hydraulik-Pumpen-Satz
Coffret de pompe hydraulique pneumatique
Pneumatische hydraulische pomp



Schnellkupplung - Tropffrei!
Raccord rapide - antigoutte!
Snelkoppeling - lekt niet!

3
320x150
x200 mm



440.0060 Hydraulischer Fußpumpen-Satz
Coffret de pompes hydrauliques à pied
Hydraulische voet pomp



Schnellkupplung - Tropffrei!
Raccord rapide - antigoutte!
Snelkoppeling - lekt niet!

4
390x260
x680 mm



440.0035 Mechanischer Spindel-Satz
Coffret de vis de force mécaniques
Mechanische spindelset



330 mm

4
1,1 kg
M18



440.0063 Manometer
Manomètre
Manomètre



Schnellkupplung - Tropffrei!
Raccord rapide - antigoutte!
Snelkoppeling - lekt niet!

610.0100 Sicherheitsfolie
Pochette de protection
Veiligheidsfolie



440.0034 KS Hydraulik PP2 auf Sauer®, Müller®, KS PP1-Werkzeug
KS Hydraulique PP2 pour Sauer®, Müller®, KS PP1 outil
Adapter KS hydrauliek PP2 op Sauer®, Müller®, KS PP1 gereedschap

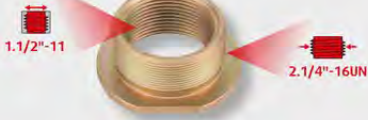

1.1/2"-11

2.1/4"-16UN

440.0036 KS Hydraulik PP2 auf Klann®-Werkzeug
KS Hydraulique PP2 pour Klann® outil
Adapter KS hydrauliek PP2 op Klann® gereedschap



1.1/2"-11

2.1/4"-14UNS

440.0408 KS Hydraulik auf Paschke®-Werkzeug
KS Hydraulique pour Paschke® outil
Adapter KS hydrauliek op Paschke® gereedschap



1.1/2"-11

M68x2



Zur Adaptierung des KS Tools PP2 Hydraulikzylinders auf das Spezialwerkzeug von

Pour l'adaptation de KS Tools PP2 vérin hydraulique à l'outil spécial de

Adapter voor gebruik van KS PP2 hydraulische cilinder op het speciaal gereedschap van.

KLANN® PASCHKE®

Zur Adaptierung des KS Tools PP2 Hydraulikzylinders auf das Spezialwerkzeug von

Pour l'adaptation de KS Tools PP2 vérin hydraulique à l'outil spécial de

Adapter voor gebruik van KS PP2 hydraulische cilinder op het speciaal gereedschap van.

MÜLLER® SAUER®

Zur Adaptierung des KS Tools PP2 Hydraulikzylinders auf das Spezialwerkzeug von

Pour l'adaptation de KS Tools PP2 vérin hydraulique à l'outil spécial de

Adapter voor gebruik van KS PP2 hydraulische cilinder op het speciaal gereedschap van.

KLANN® PASCHKE®

Zur Adaptierung des KS Tools PP2 Hydraulikzylinders auf das Spezialwerkzeug von

Pour l'adaptation de KS Tools PP2 vérin hydraulique à l'outil spécial de

Adapter voor gebruik van KS PP2 hydraulische cilinder op het speciaal gereedschap van.

MÜLLER® SAUER®

440.0038 Klann® Hydraulik auf KS PP2-Werkzeug
Adaptateur Klann® pour KS PP2 outil
Adapter Klann® hydrauliek op KS PP2 gereedschap



2.1/4"-14UNS

1.1/2"-11

440.0407 Paschke® Hydraulik auf KS PP2-Werkzeug
Système hydraulique Paschke® sur outil KS PP2
Adapter Paschke® hydrauliek op KS PP2 gereedschap



M68x2

1.1/2"-11

440.0037 KS Hydraulik PP2 auf KS Nfz-Spezialwerkzeug
KS Hydraulique PP2 pour KS outil special PL
KS hydrauliek PP2 op KS bedrijfswagens speciaalgereedschap



1.1/2"-11

2.1/2"-11UN



440.0340 Sicherungsring-Werkzeug-Satz
Jeu d'outils pour bagues de sécurité
 Set gereedschap voor borgringen

7
 12/16mm/11
 770 g



440.0100 Verstellaare Radlager-Platte
Plaque de réglage pour roulements de roues
 Verstellbare wiellagerplaat

4
 12/16mm/11
 1,98 kg



Ausbaurichtung nach Innen!
 Sens de dépose vers l'intérieur!
 Uitbouwrichting naar binnen!

440.0069 Montage-Ring Ford / Mazda / Volvo
Bague de montage Ford / Mazda / Volvo
 Montagering Ford / Mazda / Volvo

60 g



Volvo: V70 (2007→)
 S80 / V60 / XC60 / XC70
 Ford: Mondeo, S-Max
 Mazda: 6

440.0072 Montage-Gegenhalteplatte Ford / Mazda / Volvo
Anneau de montage Ford / Mazda / Volvo
 Montage-blokkeerplaat Ford / Mazda / Volvo

2
 12/16mm/11
 640 g

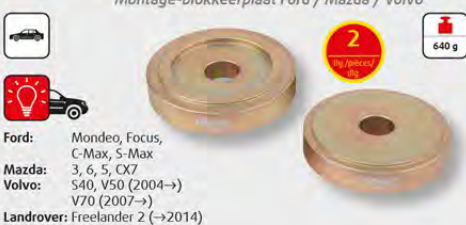

Ford: Mondeo, Focus, C-Max, S-Max
 Mazda: 3, 6, 5, CX7
 Volvo: S40, V50 (2004→), V70 (2007→)
 Landrover: Freelander 2 (→2014)

440.0075 Universal Radlager-Antriebsachsen-Naben-Satz
Jeu universel d'extraction de roulements, arbres de transmission, moyeux de roues
 Universele gereedschapset voor wiellagers, aandrijfassen, naven

16
 12/16mm/11
 11,14 kg
 161 / 22t



Kein Ausbau von ABS-Geber, Achsschenkel, Federbein oder Spurstangengelenk nötig!
 Aucune dépose de capteur ABS, triangle de suspension, suspension ou articulation de barre d'accouplement nécessaire!
 Uitbouwen van ABS-sensor, fusee, veerpot of spoorstangkogel niet nodig!

UNIVERSAL
 UNIVERSAL
 UNIVERSEEL

440.0095 Lager- und Nabenschalen-Satz
Jeu de coquilles pour roulement et moyeux de roues
 Set lager- en naafplaten

2
 12/16mm/11
 4,98 kg



Ford: C-Max
 Mazda: 3
 Volvo: S40 / V50
 Škoda: Oktavia (1996-2004)
 VW: Golf IV, Bora / Beetle
 Audi: A3, S3, TT (1999-2006)
 Seat: Leon 1, Toledo 2

+ Citroën, Peugeot, Renault, VAG
 Mit geteilter Radlager/Nabe.
 avec moyeu/roulement séparé
 met gedeeld wiellager/naaf

440.0150 Distanzschrauben-Satz für Volkswagen Radlager
Jeu de vis d'écartement pour roulements de roues Volkswagen
 Set afstandschroeven voor wiellagers Volkswagen

9
 12/16mm/11
 480 g



VW: T5, Touareg

Vorder- und Hinterachse
 Essieux avant et arrière
 Voor- en achteras

440.0105 Radlager-Satz für Volkswagen / Audi / Porsche
Jeu pour roulements de roues pour Volkswagen / Audi / Porsche
 Gereedschapset voor wiellagers voor Volkswagen / Audi / Porsche

10
 12/16mm/11
 10,33 kg



Vorderachse / Essieu avant / Vooras
 VW: Touareg
 Porsche: Cayenne, Panamera
 Audi: Q7

Ø 23 mm
 M22

ABS-Fühler wird nicht beschädigt!
 Capteur ABS non endommagé!
 ABS-sensor wordt niet beschadigd!

440.0065 Universal Werkzeug-Satz zur Kompakt-Radlagermontage
Jeu d'outils universels pour roulements de roues compacts
 Set universeel gereedschap voor monteren compacte wiellagers

9
 12/16mm/11
 7,26 kg



VW: Polo, Lupo, Fox, Touareg, T5, Crafter
 Audi: A2
 Seat: Ibiza, Cordoba
 Škoda: Fabia
 Mercedes: Vito, Viano, Sprinter
 Smart: Forfour
 Mitsubishi: Colt

440.0064 Montage-Gegenhalteplatte Volkswagen / Audi / Seat / Škoda
Contre-plaque de montage Volkswagen / Audi / Seat / Škoda
 Montage-blokkeerplaat Volkswagen / Audi / Seat / Škoda

2
 12/16mm/11
 510 g



VW: Polo, Lupo, Fox
 Audi: A2
 Seat: Ibiza, Cordoba
 Škoda: Fabia
 Smart: Forfour
 Mitsubishi: Colt

440.0071 Montage-Gegenhalteplatte Volkswagen
Bague de montage Volkswagen
 Montage-blokkeerplaat Volkswagen

2
 12/16mm/11
 840 g



VW: T5 / Touareg
 Mercedes: Vito, Viano

*Die angezeigten OE-Nummern dienen nur zur Zuordnung technischer Daten und der Verwendungszwecke.
 *Les numéros de série mettent en relation produits, caractéristiques techniques et utilisations.
 *De gemarkeerde OE nummers dienen uitsluitend voor de indeling van technische gegevens en de gebruikdoelende.



01.10.2016 - 31.03.2017

440.0073 Universal-Werkzeug zur Kompakt-Radlagerdemontage
Outillage universel pour démontage de roulements de roues compacts
 Universeel demontagegereedschap voor compacte wiellagers



7
kg (max.)
Bsp.



- VW:** Polo, Lupo, Touareg, Fox, T5, Crafter
Audi: A2
Seat: Ibiza, Cordoba
Škoda: Fabia, Rapid, Roomster
Ford: Focus, C-Max, Mondeo, S-Max, Kuga
Land Rover: Freelander 2
Mazda: 3, 5, 6, CX-7
Mercedes: Sprinter, Vito, Viano
Smart: Forfour
Volvo: V50, S40, V70, S80, XC60
Mitsubishi: Colt
BMW: 1 F20/F21 (2011-2015)
 1 E82/E88 Coupé/CAB (2006-2015)
 1 E87/E81 5D/3D (→2004)
 3 F30/F31 (2012-2015)
 3 E90/91 SED/TOU (2005-2015)

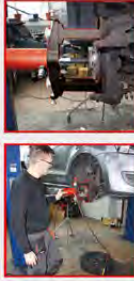

440.0500 Universal-Werkzeug zur geschraubten Radlagerdemontage
Outil universel pour montage de roulements vissés
 Universeel demontagegereedschap voor geschroefde wiellagers



7
kg (max.)
Bsp.



Vorder- und Hinterachse!
 Essieux avant et arrière
 Voor- en achters

VAG / Ford / Mazda / Toyota / Mitsubishi / Audi A4, A6 / VW Passat / Škoda Octavia / Seat Exeo etc.

Für 4-Bolzen Verschraubung!
 Vissage pour 4 boulons!
 Voor bevestiging met vier bouten!



440.0505 Universal-Werkzeug zur geschraubten Radlagerdemontage
Outil universel pour montage de roulements vissés
 Universeel demontagegereedschap voor geschroefde wiellagers



7
kg (max.)
Bsp.



Vorder- und Hinterachse!
 Essieux avant et arrière
 Voor- en achters

Opel: Insignia, Astra (2004→)
 Chevrolet: Malibu
 Saab: 95 (2010→)

Für 3-Bolzen Verschraubung!
 Vissage pour 3 boulons!
 Voor bevestiging met drie bouten!



440.0074 Universal Demontagescheibe, konisch
Couppelles universelles coniques de démontage
 Universele demontageplaat, conisch



Ø 20 mm



Passend für Spindel M20!
 Convient pour broche M20!
 Passend op spindel M20!



440.0510 Universal-Werkzeug zur geschraubten- und Kompakt-Radlagerdemontage
Outil universel pour montage de roulements vissés et compacts
 Universeel demontagegereedschap voor geschroefde en compacte wiellagers



17
kg (max.)
Bsp.



UNIVERSAL
 UNIVERSIEL
 UNIVERSEEL

Vorder- und Hinterachse!
 Essieux avant et arrière
 Voor- en achters



440.0515 Universal-Werkzeug zur geschraubten- und Kompakt-Radlagermontage und Demontage
Outil universel pour montage et démontage de roulements vissés et compacts
 Universeel gereedschap voor demonteren en monteren geschroefde en compacte wiellagers



UNIVERSAL
 UNIVERSIEL
 UNIVERSEEL

33
kg (max.)
Bsp.



Demontage
 Démontage
 Demontage

Montage
 Montage
 Montage



440.0535 Universal Werkzeug-Satz zur Kompakt-Radlagermontage
Jeu d'outils universels pour roulements de roues compacts
 Set universeel gereedschap voor montage compacte wiellagers



17
kg (max.)
Bsp.

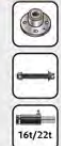

- VW:** Polo, Lupo, Fox, Touareg, T5, Crafter
Audi: A2
Seat: Ibiza, Cordoba
Škoda: Fabia
Mercedes: Vito, Viano, Sprinter
Smart: Forfour
Mitsubishi: Colt

Weitere Anwendungen mit optionalem Zubehör:
 Autres applications avec accessoires optimum:
 Andere toepassingen met optionele toebehoren:

440.0069 Volvo: S80, V60, XC60, XC70, V70 (→2007)
 Ford: Mondeo, S-Max
 Mazda: 6

440.0072 Ford: Focus, C-Max, S-Max, Mondeo, Kuga
 Mazda: 3, 6, 5, CX7
 Volvo: S40, V50 (2004→) V70 (2007→)
 Landrover: Freelander 2-14





440.0520 Antriebswellen-Einziehwerkzeug-Satz für BMW
Coffret de montage pour cardan pour BMW
 Set intrekgereedschap voor aandrijfassen BMW, mechanisch

6
 1/2, passend / eq



- BMW 1: F20/F21/E81/E82/E87/E88
- BMW X1: E84
- BMW 3: M3: F30/31 E90/E92/E93/E46
- BMW X3: F25/E83
- BMW 5: M5: GT F07 F10/F11/F18/E60/E61/E39
- BMW X5: E70/E53
- BMW 6: M6: F12/F13/E63/64
- BMW X6: E71/E72
- BMW 7: F01/F02/F03/F04/E65/E66/E38
- BMW Z4: E85/E86/E89

440.0525 Hydraulik-Antriebswellen-Einziehwerkzeug-Satz für BMW, 8,5t
Coffret de montage pour cardan hydraulique pour BMW, 8,5t
 Set hydraulisch intrekgereedschap voor aandrijfassen BMW, 8,5t

8
 1/2, passend / eq



440.0110 Radnaben-Demontage-Satz
Jeu de démontage de moyeu de roue
 Demontageset voor wielnaven

6
 1/2, passend / eq



440.0115 Antriebswellen-Auspressvorrichtung-Satz, 4- und 5-Loch
Coffret presse pour cardans, 4 et 5 trous
 Set persgereedschap voor aandrijfassen, 4 en 5 gats

2
 1/2, passend / eq



440.0119 Adapter für Schlaghammer
Adaptateur pour masse à inertie
 Adapter voor slaghamer

430 g



440.0080 Schlaghammer
Masse à inertie
 Slaghamer

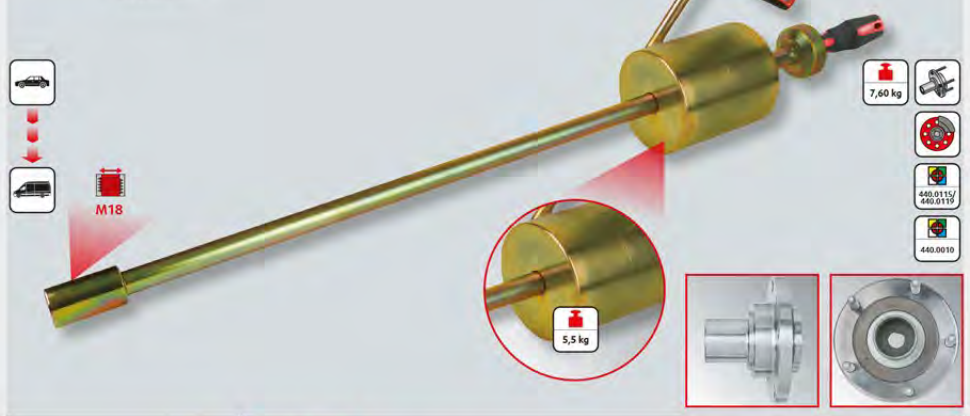

440.0090 Radlager-Satz, hinten für Mercedes
Jeu pour roulements de roues arrière pour Mercedes
 Gereedschapset voor wiellagers, achter, Mercedes

11
 1/2, passend / eq



440.0165 Radlager-Satz, vorne für Renault / Nissan / Opel
Jeu pour roulements de roue avant pour Renault / Nissan / Opel
 Gereedschapset voor wiellagers, voor, Renault / Nissan / Opel

8
 1/2, passend / eq



Hinterachse / Essieu arrière / Achteras
 Mercedes Benz: Vito und Viano (2003-2010) W639

ABS-Fühler wird nicht beschädigt!
 Capteur ABS non endommagé!
 ABS-sensor wordt niet beschadigd!

Vorderachse / Essieu avant / Vooras
 Renault: Master (2010-→)
 Nissan: Interstar (2010-→)
 Opel: Movano (2010-→)



01.10.2016 - 31.03.2017

440.0130 Radlager-Satz, vorne für Ford
Jeu pour roulement avant pour Ford
 Gereedschapset voor wiellagers, vóór, Ford



Vorderachse / Essieu avant / Vooras
 Ford: Transit, Tourneo (2000→)

Ø 78,0 mm ✓
 Ø 87,5 mm ✓



6
 15 (pieces) / Stk.



440.0135 Radlager-Satz, hinten für Ford
Jeu pour roulements de roues arrière Ford
 Gereedschapset voor wiellagers, achter, Ford



Hinterachse / Essieu arrière / Achteras
 Ford: Transit



6
 15 (pieces) / Stk.

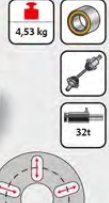

440.0125 Radlager-Satz, vorne für Citroën / Fiat / Peugeot
Jeu pour roulements de roues avant Citroën / Fiat / Peugeot
 Gereedschapset voor wiellagers, vóór, Citroën / Fiat / Peugeot



Vorderachse / Essieu avant / Vooras
 Citroën: Jumper (→2007)
 Fiat: Ducato (→2007)
 Peugeot: Boxer (→2007)



Radlagerwechsel direkt am Fahrzeug!
 Changement de roulement directement sur le véhicule!
 Wiellagers direct op de auto vervangen!

8
 15 (pieces) / Stk.



440.0085 Druckring-Satz für Radlager-Satz, vorne
Jeu de bagues de pression pour jeu de roulements de roues avant
 Set drukringen voor wiellagers, vóór



Vorderachse / Essieu avant / Vooras
 Citroën: Jumper (2007→)
 Fiat: Ducato (2007→)
 Peugeot: Boxer (2007→)



440.0113 Lagerscheibe für Radlager-Satz, vorne
für Citroën / Fiat / Ford / Peugeot
Jeu de disques pour roulements de roues avant
 Citroën / Fiat / Ford / Peugeot
 Lagerplaat voor wiellagerset, vóór, Citroën / Fiat / Ford / Peugeot



Vorderachse / Essieu avant / Vooras
 Citroën: Jumper (2007→)
 Fiat: Ducato (2007→)
 Peugeot: Boxer (2007→)
 Ford: Transit

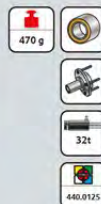

440.0123 Nabenscheibe für Radlager-Satz, vorne
für Citroën / Fiat / Ford / Peugeot
Jeu de disques de moyeux pour roulements de roues avant Citroën / Fiat / Ford / Peugeot
 Naafplaat voor wiellagerset, vóór, Citroën / Fiat / Ford / Peugeot



Vorderachse / Essieu avant / Vooras
 Citroën: Jumper (→2007)
 Fiat: Ducato (→2007)
 Peugeot: Boxer (→2007)



440.0120 Radlager-Satz, hinten für Citroën / Fiat / Ford / Peugeot
Jeu pour roulements de roues arrière Citroën / Fiat / Ford / Peugeot
 Gereedschapset voor wiellagers, achter, Citroën / Fiat / Ford / Peugeot



Hinterachse / Essieu arrière / Achteras
 Citroën: Jumper (2007→)
 Fiat: Ducato (2007→)
 Peugeot: Boxer (2007→)
 Ford: Transit



6
 15 (pieces) / Stk.



M22x2,5



440.0155 Radlager-Satz, vorne für Nissan / Opel / Renault
Jeu pour roulements de roue avant pour Nissan / Opel / Renault
 Gereedschapset voor wiellagers, vóór, Nissan / Opel / Renault



Vorderachse / Essieu avant / Vooras
 Nissan: Primastar (2002→)
 Opel: Vivaro (2002→)
 Renault: Trafic (2002→)

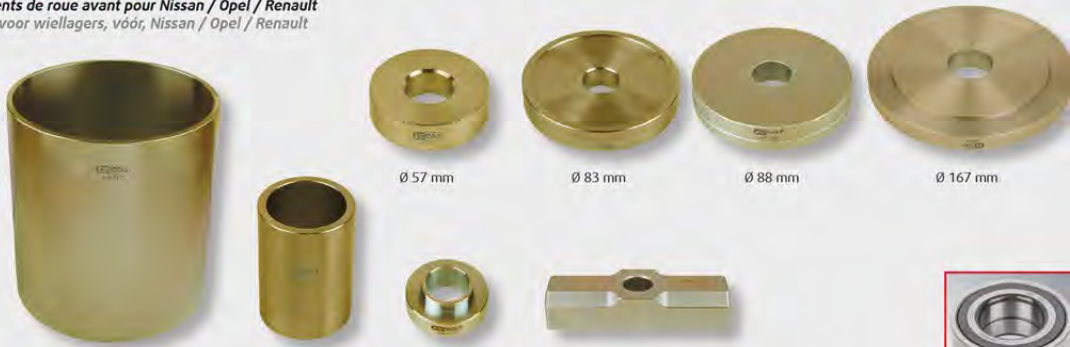

8
 15 pieces / Stk.
 9,62 kg
 16t / 22t / 32t



440.0160 Radlager-Satz, vorne für Renault / Nissan / Opel 2002 - 2010
Jeu pour roulements de roue avant pour Renault / Nissan / Opel 2002 - 2010
 Gereedschapset voor wiellagers, vóór, Renault / Nissan / Opel 2002 - 2010



Vorderachse / Essieu avant / Vooras
 Nissan: Interstar (2002-2010)
 Opel: Movano (2002-2010)
 Renault: Master (2002-2010)



9
 15 pieces / Stk.
 12,81 kg
 16t / 22t / 32t



440.0166 Druckhülse, vorne für Renault / Nissan / Opel
Douille de pression avant pour Renault / Nissan / Opel
 Drukbus, vóór, voor Renault / Nissan / Opel



Vorderachse / Essieu avant / Vooras
 Nissan: Interstar (2010→)
 Opel: Movano (2010→)
 Renault: Master (2010→)



1,06 kg
 16t / 22t / 32t
 440.0160

440.0170 Radnaben-Satz, vorne für Renault
Jeu pour roulement de moyeu de roue avant Renault
 Gereedschapset voor wielnaven, vóór, Renault



Vorderachse / Essieu avant / Vooras
 Renault: Master (1998 - 2003)

Baugleiche Modelle mit Sitz der Bremscheibe hinter der Radnabe!
 Modèles similaires avec siège des disques de frein derrière le moyeu!
 Overeenkomstige modellen met draagvlak van remschijf achter de wielnaaf!



7
 15 pieces / Stk.
 3,44 kg
 32t
 440.0160 / 440.0124

440.0085 Druckring-Satz für Radlager-Satz, vorne
Jeu de bagues de pression pour jeu de roulements de roue avants
 Set drukringen voor wiellagers, vóór, Citroën / Fiat / Ford / Peugeot



Vorderachse / Essieu avant / Vooras
 Citroën: Jumper (2007→)
 Fiat: Ducato (2007→)
 Peugeot: Boxer (2007→)



4
 15 pieces / Stk.
 2,76 kg
 32t
 440.0125

440.0140 Radnaben-Abzieher-Satz, Iveco
Coffret d'extracteur de moyeu de roue, Iveco
 Set wielnaaftrekker, Iveco



Iveco: Daily Modelle 29 - 50



4
 15 pieces / Stk.
 1,42 kg
 16t / 22t / 32t

440.0124 Antriebswellen-Auspressvorrichtung, 5-Loch
Presse pour cardans, 5 trous
 Uitpersgereedschap voor aandrijfassen, 5 gats



**UNIVERSAL
 UNIVERSEEL**



4,08 kg
 32t



440.0530 Spezialmuttern-Satz M16x1,5
Jeu d'écrous spéciaux, M16x1,5
 Set speciale moeren, M16x1,5



Citroën: Jumper
 Peugeot: Boxer
 Fiat: Ducato
 Renault: Master



5
 15 pieces / Stk.
 650 g
 440.0124

440.0136 Spezialmuttern-Satz M14x2,0
Jeu d'écrous spéciaux, M14x2,0
 Set speciale moeren, M14x2,0



Ford: Transit



5
 15 pieces / Stk.
 450 g
 440.0124

*Die angezeigten OE-Nummern dienen nur zur Zuordnung technischer Daten und der Verwendungszwecke.
 *Les numéros de série mettent en relation produits, caractéristiques techniques et utilisations.
 *De gemarkeerde OE nummers dienen uitsluitend voor de indeling van technische gegevens en de gebruikdoelende.



01.10.2016 - 31.03.2017

Druckstücke
Pièces de pression
Drukstukken

440.0181	BMW E36 (außen)	
440.0182	BMW E36 (außen)	
440.0183	BMW E36 (außen)	
440.0184	BMW E30, E36 (innen), Mercedes Benz Typ 124, Dacia Logan 2006-2013, Renault Clio III 2006-2013, Renault Grand Scenic I 2003-2009, Renault Laguna I, Renault Megane II, Renault Modus 2005-2013, Renault Scenic II	
440.0186	BMW E30, E36 (innen), Mercedes Benz Typ 124	
440.0187	BMW E30, E36 (innen)	
440.0188	Renault Master, Opel Movano, Nissan Interstar unten	
440.0189	Mercedes Benz Typ 124	
440.0191	Mercedes Benz Sprinter, VW LT 35	
440.0192	Mercedes Benz Sprinter, VW LT 35	
440.0193	Renault Master, Opel Movano, Nissan Interstar oben und unten, VW T4	
440.0194	Renault Master, Opel Movano, Nissan Interstar unten	
440.0196	Renault Master, Opel Movano, Nissan Interstar oben	
440.0197	Hyundai Trajet, Santa Fe	
440.0198	VW Crafter, Mercedes Benz Sprinter 2007>	
440.0199	VW Crafter, Mercedes Benz Sprinter 2007>	
440.0201	VW Crafter, Mercedes Benz Sprinter 2007>	
440.0202	Dacia Logan 2006-2013, Renault Clio III 2006-2013, Renault Grand Scenic I 2003-2009, Renault Laguna I, Renault Megane II, Renault Modus 2005-2013, Renault Scenic II	
440.0203	Dacia Logan 2006-2013, Renault Clio III 2006-2013, Renault Grand Scenic I 2003-2009, Renault Laguna I, Renault Megane II, Renault Modus 2005-2013, Renault Scenic II	

440.0420 Druckstück-Satz BMW E30 / E36, innen
Jeu de bagues de pression BMW E30 / E36, intérieur
Set drukkstukken BMW E30 / E36, binnen

3 (3 pièces/dg)

1,55 kg

440.0184
440.0186
440.0187

440.0180 Universal-Press-Stativ
Presses universelles
Universeel persstatief

180,0 mm

270,0 mm

1.1/2"-11

5,62 kg

9 (9 pièces/dg)

**UNIVERSAL
UNIVERSEL
UNIVERSEEL**

440.0425 Druckstück-Satz BMW E30 / E36, außen
Jeu de bagues de pression BMW E30 / E36, extérieur
Set drukkstukken BMW E30 / E36, buiten

3 (3 pièces/dg)

1,52 kg

440.0181
440.0182
440.0183

440.0445 Druckstück-Satz Volkswagen T4
Jeu de bagues de pression Volkswagen T4
Set drukkstukken Volkswagen T4

2 (2 pièces/dg)

1,34 kg

440.0191
440.0193

440.0430 Druckstück-Satz Mercedes W 124
Jeu de bagues de pression Mercedes Sprinter W 124
Set drukkstukken Mercedes W 124

3 (3 pièces/dg)

1,71 kg

440.0184
440.0186
440.0189

440.0450 Druckstück-Satz Renault
Jeu de bagues de pression Renault
Set drukkstukken Renault

3 (3 pièces/dg)

1,48 kg

Laguna 1, Megane 2, Megane Scenic 2

440.0184
440.0202
440.0203

440.0435 Druckstück-Satz Mercedes Sprinter und Volkswagen LT 35
Jeu de bagues de pression Mercedes Sprinter / LT 35
Set drukkstukken Mercedes Sprinter en Volkswagen LT 35

2 (2 pièces/dg)

1,04 kg

440.0191
440.0192

440.0455 Druckstück-Satz Renault / Nissan / Opel
Jeu de bagues de pression Renault / Nissan / Opel
Set drukkstukken Renault / Nissan / Opel

4 (4 pièces/dg)

1,34 kg

Renault Master
Nissan Interstar
Opel Movano

440.0191
440.0193

440.0440 Druckstück-Satz Mercedes Sprinter 2007> und Volkswagen Crafter
Jeu de bagues de pression Mercedes Sprinter >2007 en Volkswagen Crafter

3 (3 pièces/dg)

1,81 kg

440.0198
440.0199
440.0201

440.0470 Druckstück-Satz Hyundai
Jeu de bagues de pression Hyundai
Set drukkstukken Hyundai

3 (3 pièces/dg)

1,70 kg

Trajet, Santa Fe

440.0194
440.0197
440.0202



440.0176 Traverse oben mit Innengewinde
Potence haute avec filetage intérieur
Plaat met schroefdraad

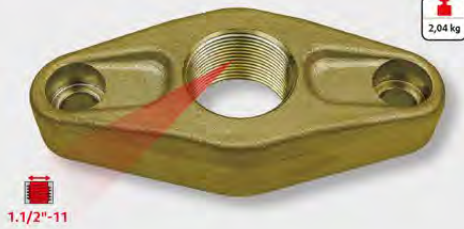

2,04 kg

1.1/2"-11

440.0179 Schraube M16x40 mm
Vis M16x40mm
Schroef M16x40mm



80 g

440.0245 Silentlagerwerkzeug-Satz, für Ford / Volvo
Jeu d'outils pour silents blocs pour Ford / Volvo
Gereedschapset voor silent blocs Ford / Volvo



1.1/2"-11

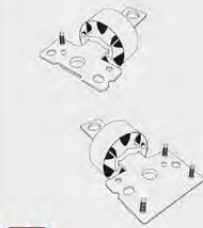

Vordere Längsstrebe - Bereich hinten /
Entroise longitudinale avant - zone arrière
Voorste langsbalk - binnenzijde, achter
Ford: Mondeo / Tourneo (2000-2007)
Ford: Mondeo / S-Max / Galaxy (2007-→)
Volvo: S60, S80, V60, V70, XC60, XC70 (2007-→)



7
15 (pieces) / 83
6,76 kg
14t / 16t / 22t



440.0230 Traggelenk-Satz, Mercedes
Jeu de rotules Mercedes
Set voor kogelgewrichten
wieldraagarm, Mercedes



1,06 kg



Mercedes-Benz:
E (211 / 219) S (220) / SL (230)
Mit 440.0238 auch für ML 163 geeignet!
Avec 440.0238 convient également pour ML 163!
Met 440.0238 ook geschikt voor ML 163!



OPTIONAL
440.0180



440.0190 Pressbügel
Presse
Persbeugel



Für Einsatz mit:
pour
voor gebruik met:
440.0230
440.0235
440.0238
440.0240

1.1/2"-11

5,78 kg

8,5t / 14t / 16t

440.0240 Traggelenk-Satz, Ford
Jeu de rotules Ford
Set voor kogelgewrichten
wieldraagarm, Ford



1,51 kg



Ford: Transit



OPTIONAL
440.0180



440.0235 Stabilisator-Kugelgelenk-Satz, Mercedes
Jeu de rotules de barre stabilisatrice Mercedes
Set voor stabilisatorstang-kogelgewrichten,
Mercedes



630 g

Mercedes-Benz:
E (211), S (220)

Ausbau des Stabilisators ohne Demontage
Stoßdämpfer und unteren Lenkerbefestigung!
Dépose du stabilisateur sans démontage des
amortisseurs et fixation du guidon inférieur!
Stabilisator uitbouwen zonder de schokdempers
en onderste bevestiging van de fusee-armen te
demonteren.



OPTIONAL
440.0180



440.0238 Traggelenk-Demontagehülse, Mercedes
Douille de démontage de rotule Mercedes
Demontagebus wieldraagarm, Mercedes



300 g



Mercedes-Benz: ML 163



OPTIONAL
440.0180



440.0210 Hinterachsbuchsen-Satz für Volkswagen /
Audi / Seat / Škoda
Jeu de douilles pour silents blocs arrière
pour Volkswagen / Audi / Seat / Škoda
Bussenset achteras, Volkswagen /
Audi / Seat / Škoda



1,65 kg



Hinterachse /
Essieu arrière / Achteras

Audi: A3 (8L) (1997-2003)
TT (8N) (1999-2006)
VW: Beetle (J) (1998-2010)
Bora (1998-2005)
Golf IV (1997-2008)
Polo (IV) (2002-2012)
Ibiza (III) (2002-2009)
Leon (I) (1999-2006)
Toledo (II) (1999-2005)
Škoda: Fabia (I) (2000-2008)
Octavia (I) (1998-2010)
Roomster, (2006-→)
Rapid (2012-→)



440.0225 Querlenkerbuchsen-Satz, hinten
Ford / Mazda / Volvo
Jeu de douilles pour biellettes arrière
Ford / Mazda / Volvo
Bussenset wieldraagarm, achter,
Ford / Mazda / Volvo



1,82 kg



Hinterachse /
Essieu arrière / Achteras
Ford: Focus, (1999-→)
C-Max 2003-→
Kuga (2008-2012)
Mazda: 3 (2003-→), 5 (2005-2010)
Volvo: V50 / S40 / C30 (2004-→)
C70 (2006-→)



440.0205 Hinterachsbuchsen-Satz für Renault
Jeu de silents blocs arrière pour Renault
Bussenset achteras, Renault



2,60 kg



Hinterachse /
Essieu arrière / Achteras
Renault: Laguna 2





440.0255 Silentlagerwerkzeug-Satz für BMW Hinterachse
 Jeu d'outils pour silent-blocs d'essieu arrière BMW
 Gereedschapset voor silent bloecs achteras BMW



21
19 (pers./dag)

12,87 kg
16t / 22t



BMW: E 81, E 82, E 82E, E 87, E 87N, E 88 (1er)
 E 90, E 90N, E 91, E 91N, E 92N, E 93, E 93N (3er)
 E 60, E 61, E 62 (5er)
 E 63, E 64 (6er)
 E 65 (7er)
 E 53 (X5)



440.0295 Silentlagerwerkzeug-Satz für Volkswagen / Audi / Seat / Škoda
 Jeu d'outils pour silent-blocs arrière pour Volkswagen / Audi / Seat / Škoda
 Gereedschapset voor silent bloecs Volkswagen / Audi / Seat / Škoda

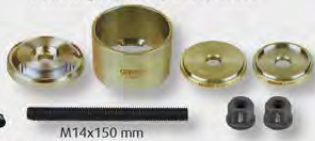

7
19 (pers./dag)

Hinterachse / Essieu arrière / Achteras
 VW: Polo 9N (2002–2009), Fox (2005→), Caddy III, Eos (2006→), Golf V (2003→), Tiguan (2007→)
 Audi: A2 (2000–2005), A3 (2003→)
 Seat: Cordoba, Ibiza (2002→) Altea (2004→), Leon (2005→)
 Škoda: Fabia (2000–2004), Roomster (2006→), Octavia (2004→)



440.0250 Silentlagerwerkzeug-Satz für BMW X5 Hinterachse
 Outils pour silent-blocs arrière BMW X5
 Gereedschapset voor silent bloecs achteras BMW X5



8
19 (pers./dag)

7,77 kg
16t / 22t



Hinterachse / Essieu arrière / Achteras
 BMW: X5 (E53)



440.0290 Doppel-Silentlager-Satz, VAG
 Jeu de silent-blocs VAG
 Set voor dubbele silent bloecs, VAG



3
19 (pers./dag)

VW: Caddy III (2004–2010), Eos (2006→), Golf V (2003–2009), Golf VI (2008→), Golf VI (2012→), Scirocco (2005→), Jetta III (2005–2010), Passat (2005–2010), Tiguan (2007→), Touran (2003→)
 Seat: Altea (2004→), Leon (2005→), Toledo (2004–2009)
 Škoda: Octavia (2004–2010)
 Audi: A3 (2005→), TT (2006–2010)



440.0270 Lenkerbuchsen-Satz für Mercedes hinten
 Jeu de silent-blocs arrière pour Mercedes
 Set voor geleidearmbussen voor Mercedes, achter



7
19 (pers./dag)

1,62 kg
16t / 22t



Hinterachse / Essieu arrière / Achteras
 Mercedes-Benz: C-, E-, S-Klasse



440.0415 Querlenkerbuchsen-Satz für Volkswagen T5 vorne
 Jeu de douilles pour silent-blocs avants pour Volkswagen T5
 Set voor wieldraagarmbussen Volkswagen T5, vóór



5
19 (pers./dag)

1,46 kg
16t / 22t



Vorderachse / Essieu avant / Vooras
 VW: T5 (2004→)



440.0285 Querlenkerbuchsen-Satz für Ford Transit vorne
 Jeu de silent-blocs avants pour Ford Transit
 Set voor wieldraagarmbussen Ford Transit, vóór

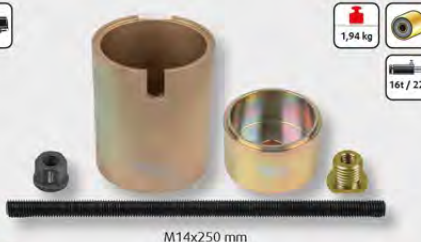

5
19 (pers./dag)

1,94 kg
16t / 22t



Vorderachse / Essieu avant / Vooras
 Ford: Transit (2000→)



440.0275 Silentlagerwerkzeug-Satz für Hyundai Hinterachse
 Jeu d'outils pour silent-blocs arrière pour Hyundai
 Gereedschapset voor silent bloecs achteras Hyundai



8
19 (pers./dag)

5,08 kg
16t / 22t



Hyundai: Santa Fe (2006–2012)

Ø 23 mm
M22



GARANTIE GRÖSSTMÖGLICHE ANWENDUNG!

440.0300 Universal Presswerkzeug-Satz
 Jeu d'outils universels pour presse
 Set universeel persgereedschap

UTILISATION AUSSI LARGE QUE POSSIBLE GARANTIE!

10 x Ø A min = 40,7 mm → Ø B max = 71,5 mm
32 verschiedene Außen- bzw. Innendurchmesser!
32 diamètres intérieurs et extérieurs différents!
32 verschillende binnen- en buitendiameters!

14 x Ø A min = 38,7 mm → Ø B max = 79,7 mm
29 verschiedene Außen- bzw. Innendurchmesser!
29 diamètres intérieurs et extérieurs différents!
29 verschillende binnen- en buitendiameters!



26 Stk./pieces/pcs
 9,67 kg
 440.0180

Druckstücke beidseitig verwendbar!
 Les pièces de pression sont utilisables des deux côtés!
 Drukstukken aan beide zijden te gebruiken!

UNIVERSAL
UNIVERSEL
UNIVERSEEL



440.0325 Universal Presswerkzeug-Erweiterungs-Satz
 Jeu d'outils universels complémentaire pour presse
 Uitbreidingsset universeel persgereedschap

UTILISATION AUSSI LARGE QUE POSSIBLE GARANTIE!

10 x Ø C min = 52,2 mm → Ø C max = 81,2 mm
10 verschiedene Innendurchmesser!
10 diamètres intérieurs différents!
10 verschillende binnendiameters!



12 Stk./pieces/pcs
 4,42 kg
 440.0300

UNIVERSAL
UNIVERSEL
UNIVERSEEL



440.9991 Hydraulik-Einheit 16 t, mit Luft-Hydraulik-Pumpe
 Unité hydraulique 16 t avec pompe pneumatique/hydraulique
 Hydraulische eenheid, 16t, met pneumatische-hydraulische pomp



max. 16t
13 Stk./pieces/pcs
OPTIONAL 440.0063
700 bar

Schnellkupplung!
 Raccord rapide!
 Snelkoppeling!

1 x 440.0005
 1 x 440.0055

440.9995 Hydraulik-Einheit 22 t, mit Luft-Hydraulik-Pumpe
 Unité hydraulique 22 t avec pompe pneumatique/hydraulique
 Hydraulische eenheid, 22t, met pneumatische-hydraulische pomp



max. 22t
13 Stk./pieces/pcs
OPTIONAL 440.0063
700 bar

Schnellkupplung!
 Raccord rapide!
 Snelkoppeling!

1 x 440.0010
 1 x 440.0055

440.9996 Hydraulik-Einheit 32 t, mit Luft-Hydraulik-Pumpe
 Unité hydraulique 32 t avec pompe pneumatique/hydraulique
 Hydraulische eenheid, 32t, met pneumatische-hydraulische pomp



max. 32t
9 Stk./pieces/pcs
OPTIONAL 440.0063
700 bar

Schnellkupplung!
 Raccord rapide!
 Snelkoppeling!

1 x 440.0025
 1 x 440.0055

01.10.2016 - 31.03.2017

GARANDÉ ET OPTIMAL GEBRUIK!

01.10.2016 - 31.03.2017

UNIVERSAL-LÖSUNG FÜR RADLAGER- UND NABE + ANTRIEBSWELLEN!

440.9992 Universal-Werkzeug Satz zur De-/Montage von Achsteilen
 Jeu d'outil universel pour montage/démontage de pièces d'essieu
 Universeel gereedschap voor demonteren en monteren assdelen

24 (24 pieces)

22,62 kg

164 / 22t

SOLUTION UNIVERSELLE POUR ROULEMENTS ET MOYEURS + ARBRES D'ENTRAÎNEMENT!

UNIVERSELE OPLOSSING VOOR WIELLAGERS EN -NABEN + AANDRIJFASSEN!

1 x 440.0100 ✓ 1 x 440.0115 ✓
 1 x 440.0075 ✓ 1 x 440.0095 ✓

KOMPLETT-LÖSUNG FÜR AKTUELLE/KÜNFTIGE KOMPAKT-RADLAGER!

440.9993 Universal-Werkzeug-Satz zur Kompakt-Radlager-De-/Montage
 Jeu d'outil universel pour montage/démontage de roulements compacts
 Universeel gereedschap voor demonteren en monteren compacte wiellagers

33 (33 pieces)

17,22 kg

164 / 22t

SOLUTION COMPLETE POUR ROULEMENTS COMPACTS ACTUELS/ULTÉRIEURS!

COMPLÈTE OPLOSSING VOOR ACTUELE EN TOEKOMSTIGE COMPACTE WIELLAGERS!

1 x 440.0065 ✓ 1 x 440.0074 ✓ 1 x 440.0064 ✓
 1 x 440.0069 ✓ 1 x 440.0071 ✓ 1 x 440.0072 ✓
 1 x 440.0073 ✓ 1 x 440.0150 ✓

440.9994 Universal-Presswerkzeug-Satz für Achsteile
 Jeu d'outil de compression universel pour pièces d'essieu
 Set universeel persgereedschap voor assdelen

38 (38 pieces)

22,62 kg

14t / 16t / 22t

Ideal zur De-/Montage von Silentlagern und Traggleiten!
 Idéal pour le montage/démontage de silentblocs et rotules de suspension!
 Ideaal voor demonteren en monteren van silent blocs en wieldraagarmen!

1 x 440.0180 ✓
 1 x 700.1550 ✓

Druckkraft Hydraulik Système hydraulique à forte pression Drukkraacht hydrauliek	Radlager Roulement de roues Wielagers	PKW VL Personenwagens
Kolbenrücklauf mit Luft Retour de piston à air Teruglopen van zuiger met lucht	Radnabe moyeux de roues Wielnaaf	Transporter Transporteur Transporter
Schlagunterstützung Renfort d'impact Slagondersteuning	Kompakt Radlager-/Nabeneinheit Unité compacte moyeu/roulement Compacte wielager/naafunit	LKW Camion Bedrijfwagens
Betriebsdruck Pression de travail Werkdruk	Silentlager Silentbloc Silent bloc	Antrieb mechanisch Entraînement mécanique Aandrijving mechanisch
Ölmenge Quantité d'huile Oliehoeveelheid	Traggelenk Arbre de suspension Fusesepen	Antrieb mit Gleithammer Entraînement avec masse à inertie Aandrijving met glijhamer
Länge Hydraulikschlauch Longueur Flexible hydraulique Lengte hydraulische slang	Außengewinde Filetage mâle Uitwendige schroefdraad	Antrieb hydraulisch Entraînement hydraulique Aandrijving hydraulisch
Fußbetätigung Actionnement par pédale Voetbediening	Innengewinde Filetage femelle Inwendige schroefdraad	Werkstattpresse presse d'atelier werkplaatspers
Gewicht Poids Gewicht	Bremscheibe Disque de frein Remschijf	
Teiligkeit Nombre de pièces Aantal delen		

für Werkzeug-Kombinationen pour combinaisons d'outils voor gereedschap combinaties
Einsatz für: Utilisation pour : Te gebruiken voor:
Zubehör Optional Accessoires en option Toebehoren optioneel
Bohrung/Spindel Alésage/broche Boring / spindel

440.0180
700.1550

KS TOOLS **PPII** **24V**

KS TOOLS **PPII** **24V**



Achse
Train
Assen

115.1185 Schlauchklemmzange
Pince à collier
Slangklemtang



115.1056 Schlauchklemmzange für Drehmomentanzug
Pince à collier avec embout pour clé dynamométrique
Slangklemtang voor het aankrijpen op moment



150.1740 Antriebswellen-Bit-Stecknuss-Satz
für Vielzahn (XZN®)-Schrauben
Jeu de douilles tournevis pour cardans XZN®
Bit-dopsleutelset voor veel tand (XZN®)-bouten van aandrijfassen



500.8420 Induktions-Heizpistolen-Satz
Set de pistolets à chaleur par induction
Inductie-heater-set



515.3100 Druckluftmontagegerät für Achsmanschetten
Expandeur de soufflet de cardan pneumatique
Pneumatische-ashoezenspreider



700.1550 Druck- und Zughülsen-Satz
Coffret d'outils pour le montage et le démontage
des roulements, joints et bagues
Druk en trekbussets



700.1270 Lagerring-Abzieher 3-armig mit Spannkonus
Extracteur de bagues intérieures de palier à
3 bras avec cône de blocage
Trekker 3-armig met spankonus voor de binnenring
van een lager



Induktions-Spule, extra lang
Bobines d'inductance, extra longues
Inductie coil, extra lang

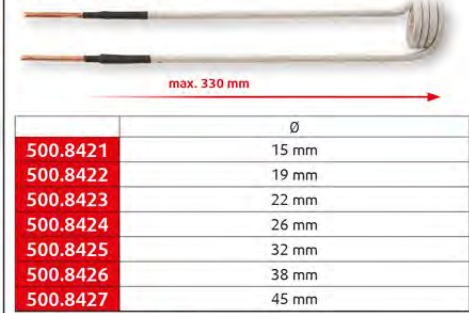

Standard Induktions-Spule
Bobines d'inductance, standard
Inductie coil, standaard lengte



500.8450 Induktions-Seilspule
Bobines d'inductance, entièrement flexible
par câble
Inductie draadcoil



HÖCHSTE TYPEN-ABDECKUNG

150.1850 Universal Gelenkwellen-Abzieher
Extracteur de cardans universel
Universele cardanas trekker



150.1724 12-kant-Antriebswellen-Kraftstecknuss, lang
Douilles à chocs 12 pans pour cardans, longues
Aandrijf-as-krachtdop, twaalfkant, lang



LE PLUS GRAND NOMBRE DE MODELES PRIS EN CHARGE

*Die angezeigten OE-Nummern dienen nur zur Zuordnung technischer Daten und der Verwendungszwecke.
*Les numéros de série mettent en relation produits, caractéristiques techniques et utilisations.
*De gemarkeerde OE nummers dienen uitsluitend voor de indeling van technische gegevens en de gebruiksdoelend.



**Autoglas
Vitrage
Autoglas**

NEUE, HOCHFESTE PE-FASER!

140.2309 Extrem hochfeste Polyethylene Austrennschnur (PE)
Cordon de découpage en polyéthylène (PE) extrêmement résistant
Extreem hoogwaardige polyethyleen (PE) snijkabel voor ruitrubbers

NOUVELLE FIBRE PE ULTRA-RESISTANTE!
NIEUWE, KRACHTIGE PE-DRAAD!

Ø 1,0 mm
25 m
1.6 kN = 160 kg = 160 daN

Gleitschicht verringert Widerstand!
La couche coulissante réduit la résistance!
Glijlaag vermindert weerstand!

911.8205 MASTER Kunststoffkeil-Satz
Jeu de pinces levier MASTER
Bekledingsvorkenset

160 - 210 mm

11
100 pieces/100

700.1179 Universal Scheibenwischarm-Abzieher
2-armig mit Knebel
Extracteurs universels à deux bras et poignée coulissante
Universele ruitenwisserarmtrekker, 2 armig met knevel

1,2 l. 45 37 M10x 105 mm

UNIVERSAL
UNIVERSEEL
UNIVERSEEL

700.1185 Universal-Scheibenwischarm-Abzieher 2-armig
Extracteurs universels de bras d'essuie-glaces à deux griffes
Universele-ruitwisserarm trekker 2-armig

10-60 34 1/2" SW 17 M12x1,25 x14 mm

700.1198 Universal Scheibenwischarm-Abzieher mit Abziehgabel
Extracteur universel de bras d'essuie-glace avec fourche
Universele ruitenwisserarmtrekker met vork

23,5 48 18 BMW 5er →05, BMW 7er →05
VW: Golf/Caddy/Passat →05
OE* T10369/1 M10x 66 mm

SW 8

15° 360°

UPDATE - JETZT ZUSÄTZLICH MIT HOCHFESTER SCHNEIDSCHNUR!

140.2360 Universal Ein-Mann-Betrieb-Scheiben-Austrenngerät
Démonte Pare-brises
Universeel raamuitsnijset

25 m 50 m
Ø 1 mm 0,6 x 0,6 mm

5
100 pieces/100

Höchster Schneidkomfort - Lackschonend!
Confort de coupe optimal : n'abime pas la peinture!
Maximaal snijkomfort - ontziet de lak!

UPDATE - DESORMAIS AVEC CORDON DE COUPE ULTRA-RESISTANT EN PE!
UPDATE - NU BOVENDIEN MET STERKE SNIJDRAAD!

620.4102 Universal-Abzieher 2-armig
Extracteurs universels à deux griffes
Universele trekker 2-armig

3 l. 10-70 65 SW 12 M10x1 x110 mm

UNIVERSAL
UNIVERSEEL
UNIVERSEEL

980.3050 Hand-Kartuschen-Pistole ohne herausstehender Schubstange 310 ml
Pistolet à cartouche sans tige de poussée, 310 ml
Kitpistool zonder transportstang

310 ml L346x H200 mm 750 g

Anzeige Restinhalt
Affichage du contenu résiduel
restinhoud indicatie

Geringer Kraftaufwand
Übersetzung 1:10
Dépense d'énergie plus faible avec un rapport 1:10
Geringe krachtspanning, overbrenging 1:10

Gürtelclip
Clip de ceinture
Riem-clip

150.1685 Druckkissen-Satz mit Handpumpe
Jeu de coussins gonflables pour portières
Drukkussenset met handpomp

4
100 pieces/100

**Bremsendienst
Freinage
Remmensevice**

150.2194 Ratschen-Bremskolben-Rücksteller, umschaltbar
Cliquet réversible pour repousse-piston
Ratel-terugdrukkereedschap wielremcilinders, omschakelbaar

280 mm

Schwimmstiel + Festsattel ✓
Ein-Kolben-Bremssattel ✓
Mehr-Kolben-Bremssattel ✓
Étrier flottant + étrier fixe ✓
Étrier de frein à un piston ✓
Étrier de frein à pistons multiples ✓
Zwevendende remklauw + vaste remklauw ✓
Remklauw met enkele zuiger ✓
Remklauw met meerdere zuigers ✓

360°

UNIVERSAL
UNIVERSEEL
UNIVERSEEL

140.2320 Profi-Armaturen-Schutztafel-Satz
Jeu de plaques de protection
Profi-beschermingsbladset

4
100 pieces/100

270x200 mm
450x300 mm

**Plakettenschaber
Grattoir à lame type rasoir**
Schraapmes

L mm B mm g

911.8126	160,0	38,0	90
----------	-------	------	----

**Ersatz-Schaberklingen
Lames de rechange**
Schrapermessen

911.8127 911.8128

tlg. pièces dlg.	L mm	B mm	S mm	g	
911.8127	5	40,0	19,5	0,29	40
911.8128	10	40,0	18,5	1,10	2

122.1290 FLAREFIX 1 Universal-Bremsleitungs-Bördelgerät-Satz mit Hydraulik-Spindel
Appareil à collets pour conduites de frein avec vérin hydraulique FLAREFIX 1
Universele remfels masterset

16
100 pieces/100

DIN SAE
max. 2 t.
4,5 (10,5) x 1,5 (4mm)

FLAREFIX





01.10.2016 - 31.03.2017

150.1965 **Universal Bremskolben-Rückstell-Werkzeug-Satz**
Jeu de repousses-piston de frein universel
 Universele remzuiger-terugstellinrichting

UNIVERSAL

Ø 45 mm
 Ø 0,4 mm
 Ø 14,5 mm - 34,5 mm

4 (16 pieces) set

150.1970 **Bremskolben-Rückstell-Werkzeug-Satz**
Jeu de repousses piston de frein
 Remzuiger-terugstellgereedschap

UNIVERSAL
 UNIVERSAL
 UNIVERSIEEL

41 (16 pieces) set

160.0710 **Universal-Entlüfterstutzen-Adaptersatz zur Bremsentlüftung**
Assortiment d'adapteurs universels pour purgeur de frein
 Universele-adapterset voor remontluchtings apparaat

AL (7,2 mm)

1 x E20V Universal
 1 x B 35 Chevrolet/Chrysler/Citroën/Ford/GM/Hyundai/Jaguar/Kia/Mitsubishi/Nissan/Ssang Young/Subaru
 1 x G 75 Mitsubishi/Rover/Subaru/Suzuki/Volvo
 1 x U90K Universal

4 (16 pieces) set

E20 (90°)
 B35
 G75
 U90K

NEU Ø 11 mm FÜR VAG!

150.1982 **ABS-Sensoren-Reibahle für VAG**
Capteurs ABS alésoir pour VAG
 Boor voor VAG ABS-sensoren

150 mm
 30 mm
 Ø 11 mm

NEUW Ø 11 MM VOOR VAG!

Audi: A3 (8P), Q3 (8U), TT (8J)
 Seat: Altea + XL, Leon, Toledo 3
 Škoda: Oktavia (1Z), Superb (3T), Yeti >2010
 VW: Golf 6/7, Beetle >2011, Golf 5, Jetta 3 + 4, Passat (3C), Scirocco >2009, Sharan >2010, Tiguan (5N), Touran >2005

150.1925 **Universal Bremskolben-Rückstell-Werkzeug-Satz mit Druckluftspindel**
Appareil de rotation/pression avec broche air comprimé universel
 Universele remzuiger-terugstellinrichting, met pneumatische spindel

3 (16 pieces) set

~40 ~1500

Anwendungen Applications Toepassingen

~90%
 Marktdeckung Couverture marché Marktafdekking

518.0340 **Bremssystem-Entlüfterschlüssel-Satz**
Jeu de clés de purge pour système de freinage
 Set ontluchtsleutels remsysteem

7-8-9-11-12-14 mm

CrV

6 (16 pieces) set

150.2305 **Easy-Ventil-Entlüfter mit Auffangflasche**
Système de purge à soupape avec bouteille de récupération
 Rem-ontluchtklep met opvangfles

1L

A B

Bremse/Kupplung Frein/accouplement Rem / koppeling

122.1300 **Gewinde-Reparatursatz M9 x 1,25 für Bremssattel-Führungsbolzen**
Coffret de réparation de filetage d'étriers de freins M9 x 1,25
 Schroefdraad-reparatieset M9 x 1,25 voor remtang-geleider bouten

TiN

16 (16 pieces) set

VAG: Golf 4, Golf Variant, Beetle, Audi A3
 Skoda / Seat etc.
 Opel: Astra G
 Ford: Focus

150.2225 **Bit-Stecknuss-Satz für Innensechskant-Schrauben am Bremssattel**
Jeu de douille-tournevis 6 pans intérieur pour étrier de frein
 Set doplsleutels voor remklauwen

3/8"

CrMo

28 mm

3 (16 pieces) set

1x 7 mm Mercedes Benz Typ 204 (C-Klasse)
 1x 8 mm Audi TT 2007→, A4 2005→, A6 2005→, A8→
 1x 9 mm Mercedes W164/W251 (M-/R-Klasse) / VW T5 / BMW

150.2230 **Bremscheiben-Prüfkoffer**
Coffret de vérification des disques de freins
 Remschijf meetset

0 - 10 mm 25 - 50 mm

3 (16 pieces) set

*Die angezeigten OE-Nummern dienen nur zur Zuordnung technischer Daten und der Verwendungszwecke.
 *Les numéros de série mettent en relation produits, caractéristiques techniques et utilisations.
 *De gemarkeerde OE nummers dienen uitsluitend voor de indeling van technische gegevens en de gebruiksdoelendoms.



Ölservice
Vidange
Olieservice

Universal-ÖlfILTER-Spannschlüssel
Clé de serrage pour filtre à huile universelle
Universele oliefilter-spansleutel



	mm
700.5005	60 - 80
700.5006	80 - 110

150.1440 VAG Öldienst-Spezialprofil-Bit
Bit à profil spécial de graissage VAG
Bit met speciaal profiel voor VAG-automobielen



Audi, Seat, Škoda, Volkswagen 2013 →
1.2, 1.4, 1.8, 2.0 TFSI / 1.6, 2.0 TDI
Audi A1, A3, A4, A5, Q5,
Volkswagen Golf MK VII, VII,
Seat Leon etc.

150.9302 8 in 1 Öldienst-Schlüssel
Clé Graissage 8-en-1
8 in 1 Olieservicesleutel



155.5005 ÖlfILTERbandschlüssel
Clé à sangle pour filtre à huile Camion
Oliefilterbandsleutel



150.1450 Master Ölblessschrauben-Gewindereparatur-Satz
Master coffret de réparation de vis de carter d'huile
Carterpanstop reparatieset

	M13 x 1,5	M15 x 1,5	M17 x 1,5	M20 x 1,5
	10x	10x	10x	10x
	1x	1x	1x	1x
	5x	5x	5x	5x

64 1/2 pieces

Audi, Citroën, BMW, Mercedes, Ford, Fiat, Honda, Mazda, Mitsubishi, Nissan, Opel, Peugeot, Porsche, Renault, Saab, Seat, Škoda, Toyota, Volvo, Volkswagen etc.

550.1291 Ölbless-Adapterschlauch für VAG 1,8L und 2,0L Benzin-Fahrzeuge
Tuyau de raccord de vidange pour VAG 1.8 + 2.0 véhicules à essence avec arrêt par inertie
Oliecarter adapterslang voor VAG 1.8 + 2.0 benzinemotoren

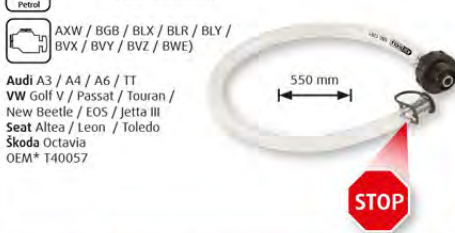

150.9210 Öldienstschlüssel-Satz für Ölfilter- und Filtergehäusedeckel
Jeu de clés pour couvercles de boîtiers de filtre et filtres à huile
Olieservicesleutelset voor oliefilters en filterdossels

3/8" 27 mm

- 27,0 x 6F (Ø 38 mm) ✓
- 32,0 x 6F (Ø 43 mm) ✓
- 36,0 x 6F (Ø 49 mm) ✓
- 64,5 x 14F (Ø 79 mm) ✓
- 64,5 x 14F (Ø 90 mm) ✓
- 74,2 x 14F (Ø 88 mm) ✓
- 86,6 x 14F (Ø 96 mm) ✓
- 88,8 x 15F (Ø100 mm) ✓
- Universal Ø63 - 83 mm

Toyota: Allion, Auris, Corolla, Prius, Voxy, Lexus (67y)
Hyundai / Kia / GM / Opel / BMW: 3er, 5er, X / Mini / Volvo / Mercedes / Smart / Ford / VW / Porsche

150.9285 Ölkontrollstab für VAG
Jauge de niveau d'huile pour VAG
Oliepeilstok voor VAG

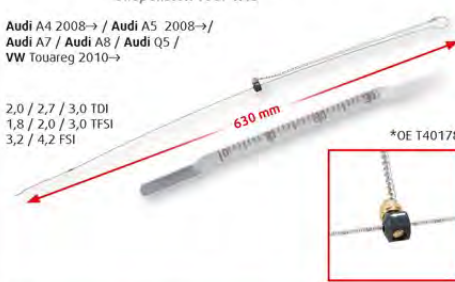

Messbecher mit flexiblem Auslauf
Broc verseur d'huile avec bec flexible
Olieschekkan, flexibele tuit



150.9234	1L
150.9235	2L

150.9365 Öldienstschlüssel-Satz für Filtergehäusedeckel
Coffret de cloches pour couvercles de filtres à huile
Oliefiltersleutelset

3/8" 32 mm

3 1/2 pieces etc.

Audi, Citroën, BMW, Mercedes, Ford, Fiat, Honda, Mazda, Mitsubishi, Nissan, Opel, Peugeot, Porsche, Renault, Saab, Seat, Škoda, Toyota, Volvo, Volkswagen etc.

150.9359 Ölauffangwanne 7,5 Liter
Bac de récupération d'huile 7,5 litres
Olie-opvangbak 7,5 Liter



150.9280 Öl-Kontroll-Messstab-Satz für Mercedes Benz
Jeu de jauge de niveau d'huile Mercedes Benz
Oliepeilstokset voor Mercedes Benz

4 1/2 pieces etc.

Audi, Citroën, BMW, Mercedes, Ford, Fiat, Honda, Mazda, Mitsubishi, Nissan, Opel, Peugeot, Porsche, Renault, Saab, Seat, Škoda, Toyota, Volvo, Volkswagen etc.

	← mm	Mercedes ID
A	920	772.7_P, 772.8_P, 716.5_V
B	930	M112, 113, 646, 647, 648
C	930	103, 104, 111, 119, 120, 137, 603
D	1220	772.6_L, G, P, V

150.9230 Universal-Trichter-Satz
Jeu d'entonnoirs universels
Trechter





Rad- / Reifenmontage
Roue
Monteren van banden / velgen

SlimPOWER Alu-Felgen Kraft-Stecknuss, lang
Douilles à chocs pour jantes aluminium SlimPOWER
SlimPOWER dopsleutel, kracht voor alu-velgen, lang



	Code	mm	L mm	D1 mm	D2 mm	T mm	kg
	515.0991	15,0	86,0	24,5	23,5	20,0	160
	515.0992	17,0	86,0	26,0	25,5	20,0	220
	515.0993	19,0	86,0	26,0	27,5	20,0	240
	515.0994	21,0	86,0	26,0	29,5	20,0	270
	515.0995	22,0	86,0	32,0	30,0	20,0	260

515.2055 Mercedes Spezial-Alu-Felgen Sonderprofil-Kraft-Stecknuss, lang
Douilles à chocs pour jantes Aluminium, longues, Mercedes
Speciale kracht dopsleutel, lang, voor alu-velgen Mercedes



515.2060 Hyundai / Kia Spezial-Alu-Felgen Sonderprofil-Kraft-Stecknuss, lang
Douilles à chocs pour jantes Aluminium, longues, Hyundai / Kia
Speciale kracht dopsleutel, lang, voor alu-velgen Hyundai / Kia



911.8197 Reifenwulstniederhalter für Reifenmontage
Maintien de talon de pneu
Bandenopleghulp voor bandenmontage



800.0156 Kunststoff-Magnet-Schale
Bol magnétique
Magneetschaal, kunststof



515.1960 Geeichter Druckluft-Reifenfüllmesser
Gonfleur d'air étalonné
Pneumatische bandenpomp, geijkt



140.5259 Rückschlagfreier Schonhammer, extra lang
Massette anti-rebond, extra-longue
Terugslagvrije kunststof hamer, extra lang



Hydraulischer Stahl-Wagenheber
Crics hydrauliques acier
Hydraulische stalen werkplaatskrik

	160.0367	160.0368
min. ↑	700 mm	800 mm
max. ↑	70 mm	90 mm
	490 mm	530 mm
	160.0363 Ø 120 mm	
kg	43 kg	54 kg



Hydraulische Rangierhilfe
Chariot de manutention hydraulique
Hydraulische rangeerkrik



100.4020 Rundwinkelpinsel für Reifenmontagepaste
Pinceau rond pour graisse à pneu
Bokkepoot voor banden-montagepasta



Reifenmontagepaste 5 kg
Seau de graisse à pneu, 5 kg
Banden-montagepasta 5 kg

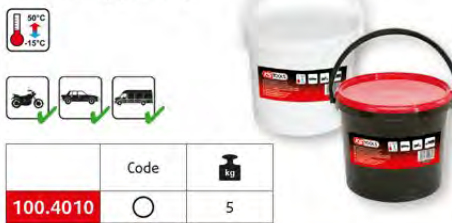

	Code	kg
	100.4010	5
	100.4015	5

150.2097 Lösezeange für geklebte Auswuchtgewichte
Pince pour masses d'équilibrage adhésives
Demontagetang voor gelijmde balanceergewichten



160.0055 Profi-Reifenwagen
Chariot pour pneus
Bandenwagen



*Die angezeigten OE-Nummern dienen nur zur Zuordnung technischer Daten und der Verwendungszwecke.
*Les numéros de série mettent en relation produits, caractéristiques techniques et utilisations.
*De gemerkte OE nummers dienen uitsluitend voor de indeling van technische gegevens en de gebruiksdoelindes.



149.0100 RDKS / TPMS Service-Sortiment für Reifendruck-Kontrollsysteme
Coffret Master pour capteur TPMS pour contrôle de la pression des pneus
 Service-assortiment voor TPMS bandenspanning-controlesystemen

149.1002 Chrysler, Dodge, Jeep, Lexus, Toyota	149.1003 Volkswagen	149.1004 Chevrolet, Chrysler, Opel, Volvo, Saab, Nissan	149.1005 Hyundai
149.1006 Ford, Volvo	149.1008 Mazda	149.1009 Hyundai, Kia	149.1016 Infiniti, Nissan, Renault
149.1019 Hyundai, Kia	149.1020 Hyundai	149.1024 Cadillac, Chevrolet, Chrysler, Citroën, Dodge, Fiat, Ford, Hyundai, Jeep, Lancia, Opel, Peugeot, Saab	149.1007 Cadillac, Chevrolet, Chrysler, Citroën, Dodge, Fiat, Ford, Hyundai, Jeep, Lancia, Lincoln, Mazda, Mercury, Opel, Peugeot, Saab
149.1025 Chrysler, Dodge, Jeep	149.1031 Dodge, Jeep, Mercedes, Smart	149.1033 Jaguar, Land Rover, Mazda	149.1035 25x 149.1036 25x



Box enthält: / La boîte contient: / De box omvat:

149.1002 2 8x	149.1019 19 8x	149.1003 3 8x	149.1020 20 8x	149.1004 4 8x	149.1024 24 4x	149.1005 5 8x	149.1025 25 4x	149.1006 6 8x	149.1031 31 4x	149.1007 7 4x	149.1033 33 4x	149.1008 8 8x	149.1035 - 25x	149.1009 9 8x	149.1036 - 25x	149.1016 16 8x	5	8	6	21	12	12	90	5	5	5
----------------------	-----------------------	----------------------	-----------------------	----------------------	-----------------------	----------------------	-----------------------	----------------------	-----------------------	----------------------	-----------------------	----------------------	-----------------------	----------------------	-----------------------	-----------------------	---	---	---	----	----	----	----	---	---	---

149.0200 RDKS / TPMS Service-Sortiment für Reifendruck-Kontrollsysteme
Coffret Master pour capteur TPMS pour contrôle de la pression des pneus
 Service-assortiment voor TPMS bandenspanning-controlesystemen

149.1010 Citroën, Fiat, Ford, Jaguar, Lancia, Land Rover, Mazda, Peugeot, Volvo	149.1011 Renault	149.1012 Citroën, Fiat, Lancia, Peugeot	149.1013 Mercedes
149.1014 Renault	149.1015 Mercedes	149.1017 Chrysler, Renault	149.1018 Renault
149.1023 Mercedes	149.1028 Dodge, Mercedes	149.1027 Alfa Romeo, Aston Martin, Audi, Bentley, BMW, Ferrari, Fiat, Mercedes, Mini, Porsche, Volkswagen	149.1028 Universal
149.1029 Universal	149.1030 Universal	149.1032 Chrysler, Dodge, Ford, Hyundai, Jaguar, Jeep, Kia, Land Rover, Mazda, Renault, Volvo	149.1035 25x 149.1036 25x



Box enthält: / La boîte contient: / De box omvat:

149.1010 10 8x	149.1026 26 4x	149.1011 11 8x	149.1027 27 4x	149.1012 12 8x	149.1028 28 4x	149.1013 13 8x	149.1029 29 4x	149.1014 14 8x	149.1030 30 4x	149.1015 15 8x	149.1032 32 4x	149.1017 17 8x	149.1035 - 25x	149.1018 18 8x	149.1036 - 25x	149.1023 23 4x	8	22	17	16	19	19	7	5	5	17
-----------------------	-----------------------	-----------------------	-----------------------	-----------------------	-----------------------	-----------------------	-----------------------	-----------------------	-----------------------	-----------------------	-----------------------	-----------------------	-----------------------	-----------------------	-----------------------	-----------------------	---	----	----	----	----	----	---	---	---	----

100.1180 RDKS / TPMS Werkzeug-Satz für Reifendruck-Kontrollsysteme
Coffret d'outils TPMS pour systèmes de contrôle de pression des pneus
 TPMS Gereedschapset voor bandenspanningcontrolesystemen

UNSER RDKS / TPMS FULLSERVICE-PAKET

1/4" 3/8"

DIN EN ISO 6789

+/-3%

13 (13 pieces)

NOTRE OFFRE SERVICE COMPLET TPMS

ONS TPMS SERVICEPAKET

- 1x Ø 2,0 mm
- 1x
- 1x 0,30 Nm
- 1x 0,45 Nm
- 1x 1-25 Nm
- 1x 1/4" + 3/8"
- 1x 1/4", 150 mm
- 2x 1/4", 11 - 12 mm
- 3x 1/4", T10 - T15 - T20
- 1x



420.0000 Befestigungs-Clip-Satz - Audi
Assortiment de clips de fixation - Audi
Clipset - Audi

AUDI



Box enthält: / La boîte contient: / De box omvat:

OE*		OE*	
420.1010	3B0838243, 3B0868243 10 x	420.1005	3B0853575 20 x
420.1001	1H0867199A, 5148191596A 10 x	420.1006	3A0853575, 3A0853575A 20 x
420.1002	1H086243, 1H0868243B 10 x	420.1007	4A0853825C 10 x
420.1653	357853575, 6991W4 20 x	420.1864	4A0853825, 4A0853825A 15 x
420.1003	1H0853585A 10 x	420.1008	1H0823397 15 x
420.1004	3A0853575 5 x	420.1009	1H0819055C01C 15 x



160
Stück
in
der
Box

340
Stück
in
der
Box



Box enthält: / La boîte contient: / De box omvat:

OE*		OE*	
420.1251	3885775 30 x	420.1409	6508197AA, F22216774A 35 x
420.1252	6998849 30 x	420.1307	16674629, N8061135 30 x
420.1901	6003423 15 x	420.1568	0153301781 50 x
420.1852	385661, 6003349, N989022 15 x	420.1373	10124502 25 x
420.1102	20699808, 6502328 50 x	420.1856	2207713, 514719044317, N9020160H 20 x
420.1253	N8043795 10 x	420.1768	30 x

420.0900 Befestigungs-Clip-Satz - Kabelbäume
Assortiment de clips de fixation - Faisceaux de câble
Clipset - Kabelbomen



235
Stück
in
der
Box

420.0905 Befestigungs-Clip-Satz - Kunststoffnieten
Assortiment de clips de fixation - Rivets en matière plastique
Clipset - kunststof nieten

BMW
VW
OPEL / GM
CHRYSLER
FORD



Box enthält: / La boîte contient: / De box omvat:

OE*		OE*	
420.1274	N8045835 20 x	420.1318	14070914 15 x
420.1870	1758535570C, 6503800 30 x	420.1104	25524005 20 x
420.1275	14063981, 6500911, N8030433 15 x	420.1304	204655395, 6004212 35 x
420.1103	6500898 25 x	420.1305	10036503 15 x
420.1051	51717002953 15 x	420.1306	10109689 15 x
420.1317	15506827 15 x	420.1276	6503860, N8046755 15 x



400
Stück
in
der
Box



Box enthält: / La boîte contient: / De box omvat:

OE*		OE*	
420.1014	N9033500A, N90335006 25 x	420.1781	9026905065 30 x
420.1015	N90796501 25 x	420.1909	35 x
420.1906	50 x	420.1782	9026904051 50 x
420.1907	30 x	420.1783	9026904053 50 x
420.1464	07119916946, N914031006203 20 x	420.1784	9026905054 25 x
420.1908	07147129160 30 x	420.1911	30 x

420.0915 Befestigungs-Clip-Satz - Schnellverschluss
Assortiment de clips de fixation - Raccord rapide
Clipset - snelsluitingen



AUDI
VW
TOYOTA
MERCEDES-BENZ
BMW

420.0920 Befestigungs-Clip-Satz - Eindrücknieten
Assortiment de clips de fixation - Rivets à pression
Clipset - indruknieten

BMW
VOLVO
MERCEDES-BENZ
VW



Box enthält: / La boîte contient: / De box omvat:

OE*		OE*	
420.1277	3831425 25 x	420.1868	171885767 20 x
420.1801	1268176 20 x	420.1857	7814.24, N0385501 40 x
420.1651	790307216, 947098, A0009903492 40 x	420.1459	A0009908492 30 x
420.1319	14005089 30 x	420.1861	N16186729901C 20 x
420.1802	9133417 20 x	420.1872	8N0863788 40 x
420.1451	A0009903792 30 x	420.1912	35 x



350
Stück
in
der
Box

350
Stück
in
der
Box



Box enthält: / La boîte contient: / De box omvat:

OE*		OE*	
420.1501	9018905013 30 x	420.1758	75521611000, 96706P0105 30 x
420.1754	9018906013 20 x	420.1855	1370853, 441035555 40 x
420.1755	128100231, 9018906001 30 x	420.1785	9018906157 20 x
420.1404	0128100501, 999100402 40 x	420.1454	A0019882981 25 x
420.1508	MU480034 25 x	420.1703	7703081184 25 x
420.1263	N3798305 40 x	420.1211	83468473 25 x

420.0925 Befestigungs-Clip-Satz - Kunststoffmuttern
Assortiment de clips de fixation - Écrous en plastique
Clipset - kunststof moeren

MITSUBISHI
CHRYSLER
FORD
GM
HONDA
MAZDA
MERCEDES-BENZ
NISSAN
TOYOTA
VW
RENAULT
FIAT



420.0930 Befestigungs-Clip-Satz - Einschraubnieten
Assortiment de clips de fixation - Rivets à visser
Clipset - inschroefnieten

AUDI
CHRYSLER
FORD
GM
HONDA

MAZDA
MERCEDES-BENZ
NISSAN
TOYOTA
VW



Box enthält: / La boîte contient: / De box omvat:

OE*		OE*	
420.1402	2042301, MB345544 30 x	420.1254	10139822, 1673046, 6508197AA 20 x
420.1352	75521611000, 9067558003 20 x	420.1255	1007932, 6502871 25 x
420.1553	1007932, 6384401A00 20 x	420.1453	A1269900392 15 x
420.1557	6686001W01, 94051933 40 x	420.1458	A9904692 15 x
420.1565	6387801E10 15 x	420.1001	1H0867199A, 5148191596A 10 x
420.1267	NAU156145, W7067135300 20 x	420.1009	1H0819055C01C 10 x



240
Stück
in
der
Box

*Die angezeigten OE-Nummern dienen nur zur Zuordnung technischer Daten und der Verwendungszwecke.
*Les numéros de série mentionnés en relation produits, caractéristiques techniques et utilisations.
*De gemarkeerde OE nummers dienen uitsluitend voor de indeling van technische gegevens en de gebruikdoeleinden.





420.0050 Befestigungs-Clip-Satz - BMW
Assortiment de clips de fixation - BMW
Clipset - BMW

BMW



Box enthält: / La boîte contient: / De box omvat:

OE*			OE*		
420.1056	51311802258	80 x	420.1058	51481938725	35 x
420.1057	51131804205	80 x	420.1053	703867299, 823867299	40 x
420.1052	51118174185	35 x	420.1059	51131960054	20 x

290
18 pieces
1/2" x 1/4"415
18 pieces
1/2" x 1/4"

Box enthält: / La boîte contient: / De box omvat:

OE*			OE*			OE*		
420.1251	3885775	25 x	420.1316	16500308, 6500787	35 x	420.1409	6508197AA, F2216774A	30 x
420.1261	N80119255	10 x	420.1265	N8031705	35 x	420.1254	10139822, 1673046, 6508197AA	20 x
420.1262	N8062895	40 x	420.1266	W7049585300	10 x	420.1271	N8052315	20 x
420.1263	N3798305	30 x	420.1267	NAU156145, W7067135300	20 x	420.1272	W7055325300	15 x
420.1553	1007932, 6384401A00	15 x	420.1268	N3882465	35 x	420.1260	B45556741, F1C216674A	30 x
420.1264	N3874965	10 x	420.1269	N3879445	15 x	420.1273	W7102505300	15 x

Befestigungs-Clip-Satz - Ford
Assortiment de clips de fixation - Ford
Clipset - Ford

FORD



420.0350 Befestigungs-Clip-Satz - Honda
Assortiment de clips de fixation - Honda
Clipset - Honda

HONDA



Box enthält: / La boîte contient: / De box omvat:

OE*			OE*			OE*		
420.1753	8942180270, 9046712020	30 x	420.1362	91550SH3003	20 x	420.1368	906835A5003	30 x
420.1351	915025P0003	8 x	420.1363	916205R2003	25 x	420.1369	01553, 906875A50030	30 x
420.1352	75521611000, 906755B003	15 x	420.1364	91578SV4003	5 x	420.1757	9046709065, 90672671003	20 x
420.1359	915665P0003	20 x	420.1365	38529689A6300	30 x	420.1370	91808SM4000	15 x
420.1360	915135E003	50 x	420.1366	91512SX0003	15 x	420.1371	91534SE0000	30 x
420.1361	915305F5003	40 x	420.1367	906876710030	15 x	420.1372	343555D2003	20 x

418
18 pieces
1/2" x 1/4"475
18 pieces
1/2" x 1/4"

Box enthält: / La boîte contient: / De box omvat:

OE*			OE*			OE*		
420.1402	2042301, MB345544	20 x	420.1416	992780405	20 x	420.1412	B09251833	15 x
420.1404	0128100501, 999100402	25 x	420.1417	992780404	20 x	420.1420	992640543A	50 x
420.1405	9095001248, B0016830200	20 x	420.1418	99249051B	50 x	420.1260	B45556741, F1C216674A	50 x
420.1406	906575A60030, 9418687, N30413356A	25 x	420.1409	6508197AA, F2216774A	30 x	420.1413	6786889101, G03158762	50 x
420.1415	BF6750033	5 x	420.1410	BF8250233	5 x	420.1419	BC1DSA145	15 x
420.1408	0155300291, 992640543A	40 x	420.1411	B1016825200	20 x	420.1766	9046709139	15 x

Befestigungs-Clip-Satz - Mazda
Assortiment de clips de fixation - Mazda
Clipset - Mazda

MAZDA



420.0450 Befestigungs-Clip-Satz - Mercedes
Assortiment de clips de fixation - Mercedes
Clipset - Mercedes

MERCEDES-BENZ



Box enthält: / La boîte contient: / De box omvat:

OE*			OE*		
420.1453	A1269900392	15 x	420.1459	A0009908492	40 x
420.1454	A0019882981	30 x	420.1460	A0019880325	30 x
420.1455	A1249900492	25 x	420.1461	A1406980260	15 x
420.1456	A0019888081	5 x	420.1462	A0019885081	20 x
420.1457	A1249880492	10 x	420.1463	A0019884481	35 x
420.1458	A9904692	15 x	420.1452	7703074022, A108980027	30 x

270
18 pieces
1/2" x 1/4"345
18 pieces
1/2" x 1/4"

Box enthält: / La boîte contient: / De box omvat:

OE*			OE*		
420.1651	790307216, 947098, A0009903492	50 x	420.1452	7703074022, A108980027	30 x
420.1652	856535	20 x	420.1701	14188380, 7703077059	35 x
420.1653	357853575, 6991W4	20 x	420.1654	698317	15 x
420.1655		20 x	420.1658	699502	25 x
420.1656	694143	25 x	420.1659	6995X3	30 x
420.1657	743707	35 x	420.1660	69945	40 x

Befestigungs-Clip-Satz - Citroën / Peugeot
Assortiment de clips de fixation - Citroën / Peugeot
Clipset - Citroën / Peugeot

PEUGEOT
CITROËN

420.0910 Befestigungs-Clip-Satz - Fiat
Assortiment de clips de fixation - Fiat
Clipset - Fiat

FIAT



Box enthält: / La boîte contient: / De box omvat:

OE*			OE*		
420.1201	4292906	30 x	420.1207	1459387	20 x
420.1202	1459487	20 x	420.1208	14188282, 46306526, 60507749	25 x
420.1203	1300433650	25 x	420.1209	14591687	25 x
420.1204	71717421	8 x	420.1210	1452387	25 x
420.1205	82456515	25 x	420.1211	83468473	30 x
420.1206	5757139	25 x	420.1212	7677865	50 x

308
18 pieces
1/2" x 1/4"



420.0500 Befestigungs-Clip-Satz - Mitsubishi
Assortiment de clips de fixation - Mitsubishi
Clipset - Mitsubishi

MITSUBISHI



Box enthält: / La boîte contient: / De box omvat:

OE*			OE*		
420.1753	8942180270, 9046712020	50 x	420.1503	MB253964	15 x
420.1501	9018905013	50 x	420.1510	HB121467	40 x
420.1502	9018906001, MU480033	30 x	420.1505	MB271999	15 x
420.1755	128100231, 9018906001	30 x	420.1511	MB696120	40 x
420.1508	MU480034	30 x	420.1506	MR200300	20 x
420.1509	MR138807	10 x	420.1512	MB846992	40 x



370
10 per set



OPEL
VAUXHALL



Box enthält: / La boîte contient: / De box omvat:

OE*			OE*			OE*		
420.1106	769061300, 813350022	30 x	420.1553	1007932, 6384401A00	15 x	420.1354	8942798070, 906675A70030	25 x
420.1751	0155300172, 9046707050	40 x	420.1563	7688257A00	20 x	420.1565	6387801E10	10 x
420.1552	68425H5000	25 x	420.1564	6684101G00	40 x	420.1566		15 x
420.1352	75521611000, 9067558003	15 x	420.1554	1099830880, 8942981190, KK37668868	30 x	420.1355	78856R4301, 906636930000	25 x
420.1561	62869N4700	50 x	420.1555	0155301393, BF8250233	8 x	420.1560	6384801G00	20 x
420.1562	62380U7400	15 x	420.1414	5378914010, 63848D400	10 x	420.1567	6385401A00	15 x

Befestigungs-Clip-Satz - Nissan
Assortiment de clips de fixation - Nissan
Clipset - Nissan

NISSAN



420.0600 Befestigungs-Clip-Satz - Opel
Assortiment de clips de fixation - Opel
Clipset - Opel

OPEL
VAUXHALL



Box enthält: / La boîte contient: / De box omvat:

OE*			OE*		
420.1603	90218614	20 x	420.1604	2345959, 7701053516, 7L5853994	50 x
420.1602	1591426, 174864	40 x	420.1605	2240582	50 x
420.1857	7814_24, N0385501	100 x	420.1606	180942	40 x



300
10 per set



RENAULT



Box enthält: / La boîte contient: / De box omvat:

OE*			OE*		
420.1558	8099905N07, 9046707043	25 x	420.1560	6384801G00	25 x
420.1201	4292906	30 x	420.1802	9133417	20 x
420.1801	1268176	20 x	420.1804	9133073	40 x
420.1057	51131804205	40 x	420.1805	3272075327462B	30 x
420.1651	790307216, 947098, A0009903492	40 x	420.1806	327462A	20 x
420.1803	171583585, 591740	40 x	420.1807	3923712	20 x

Befestigungs-Clip-Satz - Volvo
Assortiment de clips de fixation - Volvo
Clipset - Volvo

VOLVO



420.0750 Befestigungs-Clip-Satz - Renault
Assortiment de clips de fixation - Renault
Clipset - Renault

RENAULT



Box enthält: / La boîte contient: / De box omvat:

OE*			OE*		
420.1702	7703077421	50 x	420.1917		15 x
420.1916		50 x	420.1452	7703074022, A108980027	60 x
420.1703	7703081184	60 x	420.1701	14188380, 7703077059	65 x



300
10 per set



VOLKSWAGEN



Box enthält: / La boîte contient: / De box omvat:

OE*			OE*			OE*		
420.1752	9046709006	10 x	420.1773	9046709093	15 x	420.1763	9046711063	25 x
420.1755	128100231, 9018906001	25 x	420.1758	75521611000, 96706P0105	40 x	420.1764	7539533030	25 x
420.1769	9046707138	20 x	420.1774	7504933010	10 x	420.1777	9046709143	15 x
420.1770	9046707117	35 x	420.1775	7503933060	20 x	420.1778	9046708124	20 x
420.1771	9046709138	30 x	420.1762	9017905060	10 x	420.1779	9046709096	10 x
420.1772	9046709101	15 x	420.1776	677711250	20 x	420.1780	9046709050	15 x

Befestigungs-Clip-Satz
Toyota / Lexus
Assortiment de clips de fixation - Toyota / Lexus
Clipset - Toyota / Lexus

TOYOTA
LEXUS



420.0850 Befestigungs-Clip-Satz - Volkswagen
Assortiment de clips de fixation - Volkswagen
Clipset - Volkswagen

VOLKSWAGEN



Box enthält: / La boîte contient: / De box omvat:

OE*			OE*		
420.1862	1H0868243B	5 x	420.1866	1H0819055B01C	25 x
420.1863	N90833801	30 x	420.1867	443853909A	15 x
420.1006	3A0853575, 3A0853575A	20 x	420.1868	171885767	30 x
420.1864	4A0853825, 4A0853825A	15 x	420.1856	2207713, 514719044317, N9020160H	20 x
420.1011	6U085733	30 x	420.1857	7814_24, N0385501	30 x
420.1865	3B0853576	10 x	420.1869	191941142	25 x



255
10 per set

*Die angezeigten OE-Nummern dienen nur zur Zuordnung technischer Daten und der Verwendungszwecke.
*Les numéros de série mentionnent en relation produits, caractéristiques techniques et utilisations.
*De gemarkeerde OE nummers dienen uitsluitend voor de indeling van technische gegevens en de gebruikdoeleinden.





Lichttechnik
Technique d'éclairage
Lichttechnik

150.4370 LEDMAX CREE-Power LED Taschenlampe
Lampe de poche LEDMAX CREE-Power
LEDMAX Cree-Power LED zaklamp

ree-Power

IP X3
1W
85000 h
2 x AA
Ø 16 mm
50 g

5-10h
5/ +45°C

25 m

150.4240 LEDMAX LED-Akku-Arbeitslampe
Lampe LEDMAX LED à batterie
LEDMAX LED accu looplamp

280 mm

IP 54
3x 1 W LED
800 lux
= 9 h
50 mm
500 g
5/ +45°C

DC 12V 26V **AC 100V 240V**

30 WATT
POWER-ANKU
Li-Ion 3,7V 3000mAh

800 lux

150.4340 LEDMAX SUPER BRIGHT LED-Akku-Arbeitslampe
Lampe LEDMAX SUPER BRIGHT LED à batterie
LEDMAX SUPER BRIGHT LED accu-looplamp

280 mm

IP 54
3x 1 Watt SUPER BRIGHT LED
2000 lux
= 4-5 h
50 mm
930 g
5/ +45°C

DC 12V 24V **AC 100V 240V**

3 WATT
POWER-ANKU
Li-Ion 3,7V 3000mAh

2500 lux

ULTRAHELL - ULTRAWEIT!

MONSTER CREE-Power LED Lampe
Lampe MONSTER CREE-Power LED
MONSTER CREE-Power LED-lamp

IP X8

AC 100V 240V AL 120°

365g 3x 3,7V/4000mAh 5x
535g 3x 3,7V/4000mAh 7x
665g 3x 3,7V/4000mAh 9x

310 mm
320 mm
325 mm
415 mm

ULTRA CLAIR - ULTRA LARGE!
ULTRA HELDER - ULTRA VEEL!

300 m

150.4330 LEDMAX SMD-Akku-Arbeitslampe
Lampe LEDMAX SMD à batterie
LEDMAX SMD accu-looplamp

280 mm

IP 54
30 SMD
95 lm
= 9 h
50 mm
500 g
5/ +45°C

DC 12V 26V **AC 100V 240V**

30 WATT
POWER-ANKU
Li-Ion 3,7V 3000mAh

95 lm

150.4350 LEDMAX STRIPE LED-Akku-Arbeitslampe
Lampe LEDMAX STRIPE LED à batterie
LEDMAX STRIPE draadloze LED-werklamp

280 mm

IP 54
25 W STRIPE
180 lm
= 4-5 h
50 mm
950 g
5/ +45°C

DC 12V 24V **AC 100V 240V**

2,5 WATT STRIPE
POWER-ANKU
Li-Ion 3,7V 3000mAh

180 lm

	Lumen	Ø	Watt
150.4365	5000	Ø 62 mm	24W
150.4366	8000	Ø 63 mm	35W
150.4367	10000	Ø 78 mm	32W
150.4368	13000	Ø 89 mm	36W

150.4320 Werkstatt-Kabelauflöser
Enrouleur de câble électrique murale
Kabelhaspel

IP 42
20 m
3x 1,5mm²
H07RN-F
230V
1000W
2000W
5,6 kg

CE

150.4310 LEDMAX POWER STRIPE LED-Akku-Arbeitslampe,
knickbar
Lampe LEDMAX POWER STRIPE LED à batterie,
articulée
LEDMAX POWER STRIPE LED Accu-looplamp,
knickbaar

IP 64
620 Lumen
3 h
= 50.000 h
3,6 V / 1.600 mAh
290 mm
Ø 56 mm
560 / 800 g

DC 12V 24V **AC 110V 220V**

6 WATT
CITIZEN
POWER-ANKU
Li-Ion 3,6V 3000mAh

150.4296 Profi-XXL-Akku-LED-Werkstatt-Stabhandlampe
mit Expanderhalterung
Baladeuse fluorescente professionnelle grande
longueur à LEDs rechargeable
Profi-XXL-LED-Accu-Looplamp met veerbevestiging

IP 44
= 4-6 h
800 Lumen
Ø 35 mm
2 kg
-5/+45°C

Akku rechargeable ACCU

176 LED S SMD
POWER-ANKU
Li-Ion 7,4V 3000mAh

1270 - 2100 mm

150.4297 Profi-XXL-LED-Werkstatt-Stabhandlampe
mit Expanderhalterung
Baladeuse fluorescente professionnelle grande
longueur à LEDs
Profi-XXL-LED-Looplamp met veerbevestiging

IP 44
15 W
1300 Lumen
H07RN-F 2x0,75 mm
5 m
AC 220V 240V
Ø 35 mm
2,3 kg
-5/+45°C

176 LED S SMD
15 WATT

1270 - 2100 mm

Profi-Werkstatt-Stabhandlampe
Baladeuse fluorescente professionnelle
Profi-Looplamp

Ø 30 mm
Ø 35 mm

550.1376	8W	500 mm
550.1381	11W	630 mm



Druckluft-Werkzeuge
Outils à air comprimé
Pneumatisch gereedschap

515.1980 Druckluft-Reinigungs-Pistole
Pistolet de nettoyage pneumatique
Pneumatisch reinigings pistool

1/4" NPT	490-8000 U/min	237 mm/s
max. 6,3 bar (90psi)	3/8" 10,0 mm	90 dbA
700 g	<3,9 m/s²	110 dbA

Reinigt jetzt noch intensiver durch optimierte Rotationstechnologie! Assure un nettoyage encore plus intense grâce à la technologie de rotation optimisée! Reinigt nu nog intensiever door optimale rotatie-techniek



SlimPOWER Mini-Druckluft-Polierer
Mini-polisseuse pneumatique SlimPOWER
SlimPOWER mini pneumatische polijstmachine



1/4"	4.000 U/min	190 W	240,66 L/min	max. 5,5 bar
1/4" 4,8 mm	<5,08 m/s²	95 dbA	81 dbA	

	B mm	L mm	g
515.5125	55,0	140,0	600

Polierpads
Tampons de nettoyage
Polijstpads



	Ø mm		tlg. pièces dlg.	g
515.5126	50,0		5	10
515.5122	85,0		5	55
515.5127	50,0		5	10
515.5123	85,0		5	55
515.5128	50,0		5	10
515.5129	50,0		5	48
515.5124	80,0		5	102

515.5090 Druckluft-Saug-Pistole
Pistolet d'aspiration pneumatique
Pneumatisch zuigpistool

6,3 bar	96 L/min	<0,4 m/s²
92 dbA	1/4" PT	97 dbA



SlimPOWER Mini-Druckluft-Schleifmaschine
Mini-ponceuse pneumatique SlimPOWER
SlimPOWER mini pneumatische schuurmachine



1/4"	16.500 U/min	190 W	240,66 L/min	max. 5,5 bar
1/4" 4,8 mm	<5,08 m/s²	95 dbA	81 dbA	

	B mm	L mm	g
515.5100	40,0	120,0	300

Schleifpads
Disques de ponçage
Schuurpads



	Ø mm		tlg. pièces dlg.	g
515.5119	50,0	320	10	16
515.5116	75,0	320	10	19
515.5118	50,0	400	10	16
515.5115	75,0	400	10	19
515.5117	50,0	600	10	16
515.5114	75,0	600	10	19

SlimPOWER Mini-Druckluft-Schleifmaschine für kleine Pads
Mini-ponceuse pneumatique SlimPOWER pour petits tampons
SlimPOWER mini pneumatische schuurmachine voor kleine pads



1/4"	16.500 U/min	240,66 L/min	max. 5,5 bar
1/4" 4,8 mm	<5,08 m/s²	92 dbA	81 dbA

	B mm	L mm	g
515.5070	65,0	120,0	300

Schleifpads 26,7 mm
Disques de ponçage 26,7 mm
Schuurpads 26,7 mm



	Ø mm		tlg. pièces dlg.	g
515.5071	26,7	60	10	10
515.5072	26,7	80	10	20
515.5073	26,7	150	10	20
515.5074	26,7	300	10	20
515.5075	26,7	0	10	25

SlimPOWER Mini-Druckluft-Schleifmaschine für große Pads
Mini-ponceuse pneumatique SlimPOWER pour grands tampons
SlimPOWER mini pneumatische schuurmachine voor grote pads



1/4"	16.500 U/min	240,66 L/min	max. 5,5 bar
1/4" 4,8 mm	<5,08 m/s²	92 dbA	81 dbA

	B mm	L mm	g
515.5080	70,0	120,0	300

Schleifpads 50,0 mm
Disques de ponçage 50,0 mm
Schuurpads 50,0 mm



	Ø mm		tlg. pièces dlg.	g
515.5081	50,0		10	100
515.5083	50,0	80	10	90
515.5084	50,0	150	10	100
515.5082	50,0	240	10	60
515.5085	50,0	300	10	90
515.5086	50,0		10	160
515.5087	50,0		10	120

*Die angezeigten OE-Nummern dienen nur zur Zuordnung technischer Daten und der Verwendungszwecke.
*Les numéros de série mettent en relation produits, caractéristiques techniques et utilisations.
*De gemarkeerde OE nummers dienen uitsluitend voor de indeling van technische gegevens en de gebruikdoeleinden.



SlimPOWER Mini-Druckluft-Umschaltratsche
 Mini-rochet de commutation pneumatique SlimPOWER
 SlimPOWER mini pneumatische ratel, omschakelbaar



	B mm	L mm	g	
515.5005	1/4"	35,5	135,0	400
515.5010	3/8"	35,5	135,0	400
515.5015	1/2"	35,5	135,0	400



SlimPOWER Mini-Druckluft-Stabschleifer, gerade
 Mini meuleuse axiale droite pneumatique SlimPOWER
 SlimPOWER mini pneumatische staafslijper, recht



	B mm	L mm	g
515.5030	35,0	123,0	300

SlimPOWER Mini-Druckluft-Winkelstabschleifer
 Mini-meuleuse d'angle pneumatique SlimPOWER
 SlimPOWER mini pneumatische haakslijper



	B mm	L mm	g
515.5035	75,0	123,0	300

SlimPOWER Mini-Druckluft-Winkelstabschleifer
 Mini-meuleuse d'angle pneumatique SlimPOWER
 SlimPOWER mini pneumatische haakslijper



	B mm	L mm	g
515.5040	70,0	270,0	700

515.1906 Teleskop-Druckluft-Ausblaspistole mit Schutzschild
 Soufflette à bras télescopique avec écran de protection
 Telescoop pneumatisch uitblaaspistool met beschermkap



SlimPOWER Mini-Druckluft-Stabbohrmaschine
 Mini-perceuse à tige pneumatique SlimPOWER
 SlimPOWER mini pneumatische staafboormachine



	B mm	L mm	g
515.5020	35,5	145,0	400

SlimPOWER Mini-Druckluft-Winkelbohrmaschine
 Mini-perceuse coudée pneumatique SlimPOWER
 SlimPOWER mini pneumatische haakse boormachine

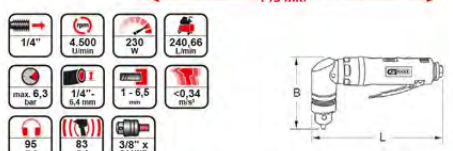

	B mm	L mm	g
515.5025	90,0	145,0	700

SlimPOWER Mini-Druckluft-Karosserie-Stichsäge
 Mini scies sauteuses pneumatiques de carrossier SlimPOWER
 SlimPOWER mini pneumatische zaag



	B mm	L mm	g
515.5045	36,0	170,0	500

SlimPOWER Mini-Druckluft-Stab-Trennschleifer, kurz
 Mini tronçonneuse-meuleuse axiale pneumatique courte SlimPOWER
 SlimPOWER mini pneumatische staafslijper, kort



	B mm	L mm	g
515.5050	60,0	125,0	400

Druckluftschlauch-Aufroller
 Enrouleur de tuyau d'air
 Oprolautoomaat voor luchtslang



	B mm	L mm	g
515.3410	3/8" - 10 mm		300
515.3415	1/2" - 13 mm		300

SlimPOWER Mini-Druckluft-Stab-Trennschleifer, lang
 Mini tronçonneuse-meuleuse axiale pneumatique longue SlimPOWER
 SlimPOWER mini pneumatische staafslijper, lang



	B mm	L mm	g
515.5060	50,0	275,0	700



Allgemeiner Werkstattbedarf
Équipement d'atelier
Universele werkplaatsuitrusting

800.0960 Aluminium-Sicherheits-Laufbühne
Marche-pied en aluminium
Aluminium veiligheids plateau



140.2226 Scheiben-Ablagetisch
Chevalet support pare-brise
Ruit-standaard



500.8090 Werkstattliege
Chariot de visite
Werkplaats rolbed



160.0790 Vakuum-Absaugpumpe mit 9,5 Liter Behälter
Pompe d'aspiration par vide 9,5 l
9,5 liter vacuüm afzuigpomp



865.0020 Servicewagen für mobile Abgasprüfstationen /
Diagnoseausrüstung
Chariot de service pour bancs d'essai des émissions
de fumées de gaz d'échappement / équipements
de diagnostic
Servicewagen voor mobiele uitlaatteststations /
diagnoseapparatuur



160.0342 Teleskop-Unterstellstütze
Étai télescopique à pédale
Telescopische steun met pedaal



160.0364 Motorhalter
Support moteur
Motorbak



150.9205 Messbecher-Satz
Jeu de verres doseurs
Set maatbekers



150.9240 Trichter-Satz
Jeu d'entonnoirs
Set trechters



Druckpump-Zerstäuber
Pulvérisateur à pompe
Pompverstuiver



150.8251	1 L	250
150.8252	2 L	330

Druckpump-Zerstäuber mit Trageriem
Pulvérisateur à pompe à bandoulière
Pompverstuiver met draagriem



150.8261	5 L	1,25 m	1140
150.8262	7 L	1,25 m	1380

*Die angezeigten OE-Nummern dienen nur zur Zuordnung technischer Daten und der Verwendungszwecke.
*Les numéros de série mettent en relation produits, caractéristiques techniques et utilisations.
*De gemarkeerde OE nummers dienen uitsluitend voor de indeling van technische gegevens en de gebruiksdoelendoms.

01.10.2016 - 31.03.2017



296 PREMIUMWERKZEUGE ALS PAKET MIT IHREM WUNSCH-WERKSTATTWAGEN ZUM SONDERPREIS!

296 OUTILS PREMIUM EN KIT COMPLET AVEC VOTRE SERVANTE COMPOSÉ POUR L'ATELIER EN OFFRE SPÉCIALE!

296 PREMIUM GEREEDSCHAPPEN IN EEN PAKKET MET UW DROOM-GEREEDSCHAPPEN TEGEN EEN SPECIALE PRIJS!

Einlagen-Pakete STARTER
Jeu d'inserts d'outils STARTER
Inlaypakket STARTER

SAFETY CONTROL SYSTEM
296
tlg./pièces/dlg.



112
tlg./pièces/dlg.

- 3-4-4,5-5-5,5-6-6,5-7-8 mm / Ø PH0 - PH1 - PH2 - PH3 /
- P20 - P21 - P22 - P23 / Ø 1,5-2-2,5-3-4-5-5,5-6-8 mm 1/16" - 5/64" - 3/32" - 7/64" - 1/8" - 9/64" - 5/32" - 3/16" - 7/32" - 1/4" /
- 2-2,5-3-4-5-6 mm 5/64" - 3/32" - 7/64" - 1/8" - 9/64" - 5/32" /
- T8 - T10 - T15 - T20 - T25 - T27 - T30 - T40 - T45 / Ø T8 - T10 - T15 - T20 - T25 - T27 - T30 - T40 - T45 /
- T820 - T825 - T827 - T830 - T835 - T840 / Ø M5 - M6 - M8 / Ø #1 - #2 - #3 /
- 4-6-8-10 mm / 4-6-8-10 mm / 6-8-10 mm / Ø #0 - #1 - #2 - #3



163
tlg./pièces/dlg.

- 4-4,5-5-5,5-6-7-8-9-10-11-12-13-14-15-16-17-18-19-20-21-22-24-27-27-30-32mm / Ø E4 - E5 - E6 - E7 - E8 - E10 - E11 - E12 - E14 - E16 - E18 - E20 - E24 /
- 5-5,5-6,5-7-8-10-12 mm / Ø PH0 - PH1 - PH2 - PH3 - PH4 / Ø P20 - P21 - P22 - P23 - P24 / Ø 3-4-5-6-7-8-10-12-14 mm /
- T5 - T6 - T7 - T8 - T9 - T10 - T15 - T20 - T25 - T27 - T30 - T40 - T45 - T50 - T55 - T60 - T70 / Ø T87 - T88 - T89 - T810 - T815 - T820 - T825 - T827 - T830 - T840 - T845 - T850 - T855 - T860 - T870 / Ø M5 - M6 - M8 /
- M5 - M6 - M7 - M8 - M9 / Ø TS10 - TS15 - TS20 - TS25 - TS27 - TS30 - TS40 - TS45 /
- 1,5-2-2,5-3-4-5-6-7-8-10 mm

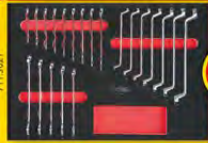

21
tlg./pièces/dlg.

- 6-7-8-9-10-11-12-13-14-15-16-17-18-19 mm
- 6x7 - 8x9 - 10x11 - 12x13 - 14x15 - 16x17 - 18x19 mm

BASICline Werkstattwagen mit STARTER-Einlagenpaket mit 296 Werkzeugen
Servante composée BASICline avec jeu d'inserts d'outils STARTER avec 296 outils
BASICline gereedschapswagen met STARTER-inlaypakket met 296 gereedschappen

BASICline

max. 30, 100%, 100 mm

	75 mm	150 mm	kg
838.0296	5	2	64,00
836.0296	5	2	64,00

MASTERline Werkstattwagen mit STARTER-Einlagenpaket mit 296 Werkzeugen
Servante composée MASTERline avec jeu d'inserts d'outils STARTER avec 296 outils
MASTERline gereedschapswagen met STARTER-inlaypakket met 296 gereedschappen

MASTERline

max. 40, 100%, 125 mm

	75 mm	150 mm	kg
878.0296	5	2	68,00
876.0296	5	2	68,00

511 PREMIUMWERKZEUGE ALS PAKET MIT IHREM WUNSCH-WERKSTATTWAGEN ZUM SONDERPREIS!

511 OUTILS PREMIUM EN KIT COMPLET AVEC VOTRE SERVANTE COMPOSÉ POUR L'ATELIER EN OFFRE SPÉCIALE!

511 PREMIUM GEREEDSCHAPPEN IN EEN PAKKET MET UW DROOM-GEREEDSCHAPPEN TEGEN EEN SPECIALE PRIJS!

Einlagen-Pakete EXTENDED
Jeu d'inserts d'outils EXTENDED
Inlaypakket EXTENDED

SAFETY CONTROL SYSTEM
511
tlg./pièces/dlg.



14
tlg./pièces/dlg.

- Ø 3-4-5-6-7-8-10-20 mm



33
tlg./pièces/dlg.

- 6-7-8-9-10-11-12-13-14-15-16-17-18-19-21-22-24 mm
- 6x7 - 8x9 - 10x11 - 12x13 - 14x15 - 16x17 - 18x19 - 21x23 mm
- 6x7 - 8x9 - 10x11 - 12x13 - 14x15 - 16x17 - 18 x19 - 21x23 mm



44
tlg./pièces/dlg.

- TS10 - TS15 - TS20 - TS25 - TS27 - TS30 - TS40 - TS45 - TS50 /
- 5-7-10-11-13-14-17-19-22-24 mm /
- 5 mm /
- T40 - T45 - T50 - T55 - T60 - T70 /
- T810 - T815 - T820 - T825 - T830 - T840 - T880 /
- M9 - M10 - M12 - M14 - M16 - M18 / Ø M16 /
- M7 - M8 - M9 - M10



32
tlg./pièces/dlg.

- 3,5-5,5-6-7-8-10 mm /
- PH0 - PH1 - PH2 - PH3 - PH4 /
- 2-2,5-3-4-5-6-8-10 mm /
- 2-2,5-3-4-5-6-8-10 mm /
- T10 - T15 - T20 - T25 - T30 - T40 - T45 - T50



180
tlg./pièces/dlg.

- 4-4,5-5-5,5-6-7-8-9-10-11-12-13-14-15-16-17-18-19-20-21-22-24-27-30-32mm / Ø E4 - E5 - E6 - E7 - E8 - E10 - E11 - E12 - E14 - E16 - E18 - E20 - E24 /
- 1,3-1,5-2-2,5-3-4-5-6-7-8-10-12-14 mm /
- 4-5-6,5-8-10-12 mm / Ø PH0 - PH1 - PH2 - PH3 - PH4 / Ø P20 - P21 - P22 - P23 - P24 /
- T5 - T6 - T7 - T8 - T9 - T10 - T15 - T20 - T25 - T27 - T30 - T40 - T45 - T50 - T55 - T60 - T70 /
- T87 - T88 - T89 - T810 - T815 - T820 - T825 - T827 - T830 /
- M5 - M6 - M8 - M9 / Ø TS10 - TS15 - TS20 - TS25 - TS27 - TS30 - TS40 - TS45



208
tlg./pièces/dlg.

- 2-2,5-3-3,5-4-4,5-5-5,5-6-6,5-7-8 mm / Ø PH00 - PH0 - PH1 - PH2 - PH3 - PH4 /
- P200 - P20 - P21 - P22 - P23 - P24 / Ø 1,5-2-2,5-3-3,5-4-4,5-5-5,5-6-7-8-9-10-11-12-13 mm 1/16" - 5/64" - 3/32" - 7/64" - 1/8" - 9/64" - 5/32" - 3/16" - 7/32" - 1/4" - 9/32" - 5/16" - 11/32" - 3/8" - 7/16" - 1/2" /
- 2-2,5-3-4-5-6 mm 5/64" - 3/32" - 7/64" - 1/8" - 9/64" - 5/32" /
- 6-8-10 mm / Ø T5 - T6 - T7 - T8 - T9 - T10 - T15 - T20 - T25 - T27 - T30 - T40 - T45 /
- T85 - T86 - T87 - T88 - T89 - T810 - T815 - T820 - T825 - T827 - T830 - T835 - T840 - T845 /
- Ø M5 - M6 - M8 / Ø #1 - #2 - #3 / Ø #1 - #2 - #3 - #4 /
- 4-6-8-10 mm / Ø #0 - #1 - #2 - #3 / Ø TS10 - TS15 - TS20 - TS25 - TS27 - TS30 - TS40 - TS45 - TS50

BASICline Werkstattwagen mit EXTENDED-Einlagenpaket mit 511 Werkzeugen
Servante composée BASICline avec jeu d'inserts d'outils EXTENDED avec 511 outils
BASICline gereedschapswagen met EXTENDED-inlaypakket met 511 gereedschappen

BASICline

max. 30, 100%, 125 mm

	75 mm	150 mm	kg
838.7511	5	2	64,00
836.7511	5	2	64,00

MASTERline Werkstattwagen mit EXTENDED-Einlagenpaket mit 511 Werkzeugen
Servante composée MASTERline avec jeu d'inserts d'outils EXTENDED avec 511 outils
MASTERline gereedschapswagen met EXTENDED-inlaypakket met 511 gereedschappen

MASTERline

max. 40, 100%, 125 mm

	75 mm	150 mm	kg
878.7511	5	2	68,00
876.7511	5	2	68,00

OPTIONAL EN OPTION OPTIONEEL

Ihr Partner / Votre partenaire / Uw dealer



Seligenstädter Grund 10 - 12
D - 63150 Heusenstamm
Deutschland
Tel.: +49 6104 4974-0
Fax.: +49 6104 4974-11
e-mail: kstools@kstools.de
www.kstools.com



Alle Preise zzgl. der gesetzlichen Mehrwertsteuer. Mit Erscheinen dieses Prospektes verlieren alle vorangegangenen Preise hiermit ihre Gültigkeit. Verkauf nur an den Fachhandel. Druckfehler, Irrtümer und technische Änderungen vorbehalten. Preise gültig bis zum 31.03.2017.

Tous les prix sont hors TVA. Suite à la publication du prospectus actuel, les anciens prix perdent leur validité. Nous ne vendons qu'aux distributeurs. Sous réserve des erreurs d'impression, erratum et modifications techniques. Les prix sont valables jusqu'au 31.03.2017

Alle prijzen zijn excl. Btw. Met het verschijnen van deze folder komen alle voorgaande actieprijzen te vervallen. Verkoop alleen via de vakhandel. Druk- en zetfouten, technische veranderingen en vergissingen voorbehouden. Prijzen zijn geldig tot 31.03.2017.